

FURUNO

OPERATOR'S MANUAL

MARINE RADAR

MODEL 1835

MODEL 1935

Model **MODEL 1945**

ECF

(Elemental Chlorine Free)

The paper used in this manual
is elemental chlorine free.

FURUNO ELECTRIC CO., LTD.

9-52 Ashihara-cho,
Nishinomiya, 662-8580, JAPAN

• FURUNO Authorized Distributor/Dealer

All rights reserved. Printed in Japan

Pub. No. OME-35790-D2

(ETMI) MODEL1835/1935/1945

A : FEB. 2009

D2 : AUG. 09, 2016



0 0 0 1 7 0 2 4 5 1 3

IMPORTANT NOTICES

General

- This manual has been authored with simplified grammar, to meet the needs of international users.
- The operator of this equipment must read and follow the descriptions in this manual. Wrong operation or maintenance can cancel the warranty or cause injury.
- Do not copy any part of this manual without written permission from FURUNO.
- If this manual is lost or worn, contact your dealer about replacement.
- The contents of this manual and equipment specifications can change without notice.
- The example screens (or illustrations) shown in this manual can be different from the screens you see on your display. The screens you see depend on your system configuration and equipment settings.
- Save this manual for future reference.
- Any modification of the equipment (including software) by persons not authorized by FURUNO will cancel the warranty.
- The following concern acts as our importer in Europe, as defined in DECISION No 768/2008/EC.
 - Name: FURUNO EUROPE B.V.
 - Address: Ridderhaven 19B, 2984 BT Ridderkerk, The Netherlands
- All brand and product names are trademarks, registered trademarks or service marks of their respective holders.

How to discard this product

Discard this product according to local regulations for the disposal of industrial waste. For disposal in the USA, see the homepage of the Electronics Industries Alliance (<http://www.eiae.org/>) for the correct method of disposal.

How to discard a used battery

Some FURUNO products have a battery(ies). To see if your product has a battery, see the chapter on Maintenance. Follow the instructions below if a battery is used. Tape the + and - terminals of battery before disposal to prevent fire, heat generation caused by short circuit.

In the European Union

The crossed-out trash can symbol indicates that all types of batteries must not be discarded in standard trash, or at a trash site. Take the used batteries to a battery collection site according to your national legislation and the Batteries Directive 2006/66/EU.

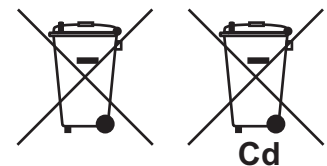

In the USA

The Mobius loop symbol (three chasing arrows) indicates that Ni-Cd and lead-acid rechargeable batteries must be recycled. Take the used batteries to a battery collection site according to local laws.

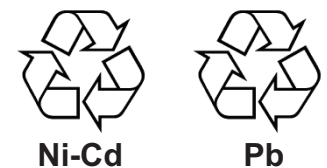

In the other countries

There are no international standards for the battery recycle symbol. The number of symbols can increase when the other countries make their own recycle symbols in the future.



SAFETY INSTRUCTIONS

Read these safety instructions before you operate the equipment.



WARNING

Indicates a condition that can cause death or serious injury if not avoided.



CAUTION

Indicates a condition that can cause minor or moderate injury if not avoided.



Warning, Caution



Prohibitive Action



Mandatory Action



WARNING

Radio Frequency Radiation Hazard

The radar antenna sends the electromagnetic radio frequency (RF) energy. This energy can be dangerous to you, especially your eyes. Do not look at the radiator or near the antenna when the antenna is rotating.

The distances at which RF radiation levels of 100 W/m², 50 W/m² and 10 W/m² exist are shown in the table.

Note: If the antenna unit is installed at a close distance in front of the wheel house, prevent the transmission in that area to protect passengers and crew from microwave radiation. Set the [Sector Blanks] in the [System] menu.

Antenna unit: RSB-0071-057

XN10A-RSB-0070-064, XN10A-RSB-0073-064

XN12A-RSB-0070-059, XN12A-RSB-0073-059







Model	Distance to 100 W/m ² point	Distance to 10 W/m ² point
1835	Worst case 0.1 m	Worst case 2.2 m
1935	Worst case 0.2 m	Worst case 2.2 m
1945	Worst case 0.2 m	Worst case 2.4 m





Antenna unit: RSB-0071-057A

XN10A-RSB-0070-064A, XN10A-RSB-0073-064A

XN12A-RSB-0070-059A, XN12A-RSB-0073-059A

Model	Distance to 100 W/m ² point	Distance to 50 W/m ² point	Distance to 10 W/m ² point
1835	—	Worst case 0.0 m	Worst case 1.0 m
1935	—	Worst case 0.2 m	Worst case 1.2 m
1945	Worst case 0.1 m	Worst case 0.2 m	Worst case 1.7 m

 WARNING	
	<p>ELECTRICAL SHOCK HAZARD Do not open the equipment.</p> <p>Only qualified persons can work inside the equipment.</p>
	<p>Turn off the power before you service the antenna unit. Post a warning sign near the power switch not to turn on the power while you service the antenna unit.</p> <p>Prevent the potential risk of being struck by the rotating antenna and exposure to RF radiation hazard.</p>
	<p>When you work on the antenna unit, wear a safety belt and hard hat.</p> <p>Serious injury or death can result if a person falls from the radar antenna mast.</p>
	<p>Do not disassemble or modify the equipment.</p> <p>Fire or electrical shock can occur.</p>
	<p>Turn off the power immediately if water leaks into the equipment or smoke or fire is coming from the equipment.</p> <p>Failure to turn off the equipment can cause fire or electrical shock.</p>

 WARNING	
	<p>Use the correct fuse.</p> <p>A wrong fuse can damage the equipment and cause fire.</p>
	<p>Keep heater away from the equipment.</p> <p>Heat can change the equipment shape and melt the power cord, which can cause fire or electrical shock.</p>
	<p>Do not put liquid-filled containers on the top of the equipment.</p> <p>Fire or electrical shock can occur if a liquid spills into the equipment.</p>
	<p>Do not operate the equipment with wet hands.</p> <p>Electrical shock can occur.</p>



WARNING



Do not depend on one navigation device for the navigation of the ship. The navigator must check all aids available to confirm position. Electronic aids are not a replacement for basic navigation principles and common sense.

- The ARPA automatically tracks an automatically or manually acquired radar target and calculates its course and speed, indicating them by a vector. Since the data from the auto plotter depend on the selected radar targets, the radar must be optimally tuned for use with the auto plotter, to ensure required targets will not be lost or unnecessary targets like sea returns and noise will not be acquired and tracked.
- A target is not always a landmass, reef, ship, but can also be returns from the sea surface and from clutter. As the level of clutter changes with the environment, the operator must correctly adjust the **A/C SEA**, **A/C RAIN** and **GAIN** controls so that the target echoes do not disappear from the radar screen.



CAUTION

The plotting accuracy and response of this ARPA meets IMO standards. The tracking accuracy is affected by the following:

- The tracking accuracy is affected by course change. One to two minutes is required to restore vectors to full accuracy after a sudden course change. (The actual amount depends on gyrocompass specifications.)
- The amount of tracking delay is inversely proportional to the relative speed of the target. Delay is on the order of 15-30 seconds for high relative speed; 30-60 seconds for low relative speed.

The data from ARPA and AIS are intended for reference purposes only.

Check all available navigation aids to determine target movement.

WARNING LABELS

Warning labels are attached to the equipment. Do not remove any label. If a label is missing or damaged, contact a FURUNO agent or dealer about replacement.

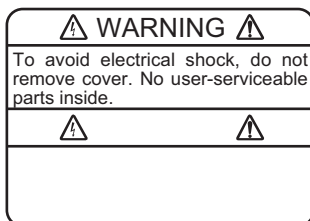

DISPLAY UNIT

Name: Warning Label 1
 Type: 86-003-1011-3
 Code No.: 100-236-233-10

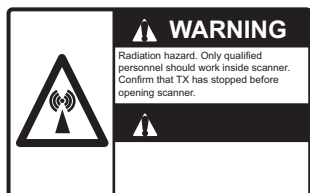

ANTENNA UNIT

Name: Warning Sticker
 Type: 03-142-3201-0
 Code No.: 100-266-890-10

TFT LCD

The high quality TFT (Thin Film Transistor) LCD displays 99.999% of its picture elements.

The remaining 0.001% may drop out or light, however this is an inherent property of the LCD; it is not a sign of malfunction.

TABLE OF CONTENTS

FOREWORD.....	ix
SYSTEM CONFIGURATION	xii
1. DESCRIPTION OF OPERATION	1-1
1.1 Controls	1-1
1.2 How to Turn the Radar On/Off and Transmit.....	1-2
1.3 Display Indications.....	1-3
1.4 How to Adjust Display Brilliance, Panel Dimmer	1-4
1.5 Menu Description.....	1-4
1.6 Tuning.....	1-6
1.7 Display Modes	1-7
1.7.1 How to select the display mode.....	1-7
1.7.2 Description of display modes	1-8
1.8 How to Select a Range Scale.....	1-9
1.9 How to Adjust the Gain (sensitivity).....	1-10
1.10 How to Reduce the Sea Clutter.....	1-11
1.11 How to Reduce the Rain Clutter	1-12
1.12 Automatic Adjustments of Sea and Rain Clutters	1-13
1.13 Cursor.....	1-14
1.14 Interference Rejector.....	1-15
1.15 How to Measure the Range to a Target	1-16
1.15.1 How to adjust range ring brilliance	1-16
1.15.2 How to measure the range with a VRM.....	1-17
1.15.3 How to select VRM unit	1-17
1.16 How to Measure the Bearing to a Target.....	1-18
1.16.1 How to measure the bearing with an EBL	1-18
1.16.2 EBL reference	1-19
1.17 How to Measure the Range and Bearing Between Two Targets	1-19
1.18 How to Select a Pulselength.....	1-20
1.19 Target Alarm.....	1-21
1.19.1 How to set a target alarm zone	1-22
1.19.2 How to stop the audio alarm.....	1-22
1.19.3 How to select the alarm type	1-23
1.19.4 How to sleep a target alarm temporarily.....	1-23
1.19.5 How to deactivate a target alarm.....	1-24
1.19.6 How to select the target strength which triggers a target alarm	1-24
1.19.7 How to turn the buzzer on/off	1-24
1.20 How to Off-center the Display.....	1-25
1.20.1 How to select the off-center mode.....	1-25
1.20.2 Off-center the display	1-25
1.21 Zoom	1-27
1.21.1 Zoom mode	1-27
1.21.2 How to zoom	1-27
1.22 Echo Stretch	1-29
1.23 Echo Average	1-29
1.24 Target Trails	1-30
1.24.1 Trail time.....	1-30
1.24.2 How to start, stop the trails	1-31
1.24.3 Trail mode	1-31
1.24.4 Trail gradation	1-32
1.24.5 Trail color.....	1-32
1.24.6 Trail level	1-33

TABLE OF CONTENTS

1.24.7	How to restart, stop the trails	1-33
1.24.8	Narrow trails	1-34
1.24.9	Your ship trail	1-34
1.25	How to Send the Target Position and Enter the Origin Mark	1-34
1.26	How to Hide the Heading Line Temporarily	1-35
1.27	Presentation Brilliance	1-35
1.28	Custom Setup	1-36
1.28.1	About custom setup	1-36
1.28.2	Description of custom setup items	1-36
1.28.3	How to set custom setups	1-37
1.29	How to Program Function Keys (F1, F2 and F3 keys)	1-38
1.30	Noise Rejector	1-39
1.31	Wiper	1-39
1.32	How to Reduce Second-trace Echoes	1-40
1.33	Watchman	1-40
1.34	Color Selections	1-41
1.34.1	Preset colors	1-41
1.34.2	Custom colors	1-42
1.35	Navigation Data	1-43
1.35.1	Navigation data during standby	1-43
1.35.2	Navigation data at the bottom of the screen	1-43
1.36	Dynamic Range	1-44
1.37	Characteristics Curve	1-45
1.38	Waypoint Marker	1-46
1.39	Alarm Message	1-46
1.40	Echo Area	1-48
1.41	Initial Sub Menu	1-49
1.41.1	How to open the Initial sub menu	1-49
1.41.2	Description of Initial sub menu	1-49
1.42	Units Sub Menu	1-51
1.43	Sector Blank	1-52
1.44	Other Menu Items	1-53
1.44.1	Menu items on the [Brill/Color] menu	1-53
1.44.2	Menu items on the [Display] menu	1-55
1.44.3	Menu items on the [Echo] menu	1-56
1.45	Remote Display	1-56
2.	DESCRIPTION OF RADAR	2-1
2.1	General	2-1
2.1.1	Minimum and maximum ranges	2-1
2.1.2	Radar resolution	2-2
2.1.3	Bearing accuracy	2-3
2.1.4	Range measurement	2-3
2.2	False Echoes	2-3
2.2.1	Multiple echoes	2-3
2.2.2	Sidelobe echoes	2-4
2.2.3	Virtual image	2-4
2.2.4	Shadow sector	2-5
2.3	SART (Search and Rescue Transponder)	2-6
2.3.1	SART description	2-6
2.3.2	General remarks on receiving SART	2-7
2.4	RACON	2-8

3.	ARPA OPERATION	3-1
3.1	Precautions for Use	3-1
3.2	Controls for Use with ARPA	3-1
3.3	ARPA Display On/Off	3-2
3.4	How to Acquire and Track the Targets	3-2
3.4.1	Manual acquisition	3-2
3.4.2	Automatic acquisition	3-3
3.5	How to Stop the Tracking of ARPA Target	3-3
3.5.1	How to stop the tracking of selected targets	3-3
3.5.2	How to stop the tracking of all targets	3-3
3.6	Vector Attributes	3-4
3.6.1	What is a vector?	3-4
3.6.2	Vector time and vector reference	3-4
3.6.3	Vector of your ship	3-5
3.7	History Display (target past position)	3-6
3.8	ARPA Target Data	3-7
3.9	CPA/TCPA Alarm	3-8
3.10	Proximity Alarm	3-9
3.11	Lost Target	3-10
3.12	Symbol Color	3-10
4.	AIS OPERATION	4-1
4.1	Controls for Use with AIS	4-1
4.2	AIS Display On/Off	4-1
4.3	AIS Symbols	4-2
4.4	Activating, Sleeping Targets	4-2
4.5	AIS Target Data	4-3
4.6	How to Sort Targets	4-4
4.7	Display Range	4-4
4.8	How to Display the Targets within a Specific Sector	4-5
4.9	Number of Targets to Display	4-5
4.10	Vector Attributes	4-6
4.10.1	What is a vector?	4-6
4.10.2	Vector time and vector reference	4-6
4.11	History Display (target past position)	4-7
4.12	CPA/TCPA Alarm	4-8
4.13	Proximity Alarm	4-9
4.14	Lost Target	4-9
4.15	Symbol Color	4-10
4.16	How to Ignore Slow Targets	4-10
5.	GPS OPERATION	5-1
5.1	Navigator Mode	5-1
5.2	Datum	5-1
5.3	WAAS Setup	5-2
5.4	Satellite Monitor	5-3
5.5	Cold Start	5-4
6.	MAINTENANCE, TROUBLESHOOTING	6-1
6.1	Preventive Maintenance	6-2
6.2	Fuse Replacement	6-2
6.3	Magnetron Life	6-3
6.4	Simple Troubleshooting	6-4
6.5	Advanced-level Troubleshooting	6-5
6.6	Diagnostic Test	6-7
6.7	LCD Test	6-9

TABLE OF CONTENTS

6.8 ARPA Test 6-10
6.9 GPS Test..... 6-11

APPENDIX 1 MENU TREEAP-1
APPENDIX 2 GEODETIC CHART LISTAP-5
SPECIFICATIONSSP-1
INDEX.....IN-1

FOREWORD

A Word to the Owner of the MODEL1835/MODEL1935/MODEL1945 Marine Radar

Congratulations on your choice of the FURUNO MODEL1835/MODEL1935/MODEL1945 Marine Radar. We are confident you will see why the FURUNO name has become synonymous with quality and reliability.

Since 1948, FURUNO Electric Company has enjoyed an enviable reputation for innovative and dependable marine electronics equipment. This dedication to excellence is furthered by our extensive global network of agents and dealers.

Your equipment is designed and constructed to meet the rigorous demands of the marine environment. However, no machine can perform its intended function unless properly installed and maintained. Please carefully read and follow the operation and maintenance procedures set forth in this manual.

We would appreciate feedback from you, the end-user, about whether we are achieving our purposes.

Thank you for considering and purchasing FURUNO equipment.

Features

The MODEL1835/MODEL1935/MODEL1945 (the MODEL1835 series herein after) display ships, lands, etc. on a 10.4-inch color LCD. You can operate this equipment with the keys, knob controls and Cursorpad.

The main features are as shown below.

- The MODEL1835 series has the following models:

Model	Output power	Max range	Size and type for radar antenna	Antenna rotation
MODEL1835	4 kW	36 nm	60 cm, Radome	24 RPM
MODEL1935	4 kW	48 nm	100 cm, Open	24/48 RPM
MODEL1945	6 kW	64 nm	120 cm, Open	

- Bright 10.4-inch LCD is visible in direct sunlight.
- An easy to understand user interface with on-screen menu
- “Fog-Free” color LCD provides clear view in any weather conditions.
- Echo area display with full screen provides observation of a wider range around the vessel.
- Optional Auto Plotter ARP-11 is available for ARPA operation.
- User programmable function keys
- AIS data can be displayed with connection of FURUNO AIS Transponder/Receiver.
- Echoes in yellow, green, orange or multiple colors

Radar Type and Function Availability

This radar series is available in four types: [River], [Sea], [IEC] and [Russian-River], and function availability depends on type. The table below shows type and function availability.

[River]: For river, [Sea]: For sea, [IEC]: IEC compliant radar, [Russian-River]: For Russian river

Type and function availability

Item	Type			
	River	Sea	IEC	Russian-River
Automatic menu closure	Menu does not close automatically.		Menu closes automatically when there is no menu operation for 10 seconds.	
Effective radius dot count	240 dots		210 dots	
Echo color	Select the echo display color among [Yellow], [Green], [Orange] or [Multi].		Select the echo display color among [Yellow], [Green] or [Orange].	
Echo color customizing	Can customize the echo display color.		Can not customize the echo display color.	
Echo area	Select the display area from [Normal] or [Full Screen].		Can not select. Display area is circle only.	
Base text display	Can show or hide the base text indications.		Can not hide the base text indications.	
Range preset	Select the radar ranges to use.			Can not select the radar ranges to use.
Unit defaults 1) range 2) speed	1) KM 2) km/h, m/s	1) NM 2) kn		1) KM 2) km/h, m/s
Bearing scale	Graduation every 1°, 5°, 10°, 30°, no numeric indication, displayed in the effective radius		Graduation every 1°, 5°, 10°, 30°, numeric indication every 30°, displayed out of the effective radius	
VRM unit	Can set the VRM unit independently from the range unit.		Can not set the VRM unit independently from the range unit.	
Range unit	Can change the range unit when transmitting.		Can not change the range unit in transmit. Only in standby.	
AIS symbol color	Select the AIS symbol color from [Green], [Red], [Blue], [White] or [Black].		Select the AIS symbol color from [Green], [Blue], [White] or [Black].	
Vector reference	Select the display mode for the vector from [Relative] or [True].		[True]	

Item	Type			
	River	Sea	IEC	Russian-River
Pulselength	<ul style="list-style-type: none"> • 2NM/4KM/2SM: MP • 4NM/8KM/4SM: LP 			<ul style="list-style-type: none"> • 2NM/4KM/2SM: SP or MP • 4NM/8KM/4SM: MP or LP
The rule for the numbering of ARPA targets	Non-IEC system		IEC system	
Marks temporary hidden by pressing and holding the CANCEL/HL OFF key	Heading line, all marks (EBL, VRM, target alarm zone, etc.)		Heading line, vector of your ship (with ARP-11), north marker	

Note on Chinese font: The Chinese font used in this equipment is Ricoh Company Ltd.'s Ricoh bitmap font.

中文字型由北京字研技术开发中心提供

Program No.

- 0359246-03.**

** denotes minor modifications.

SYSTEM CONFIGURATION

Basic configuration is shown below with solid line.

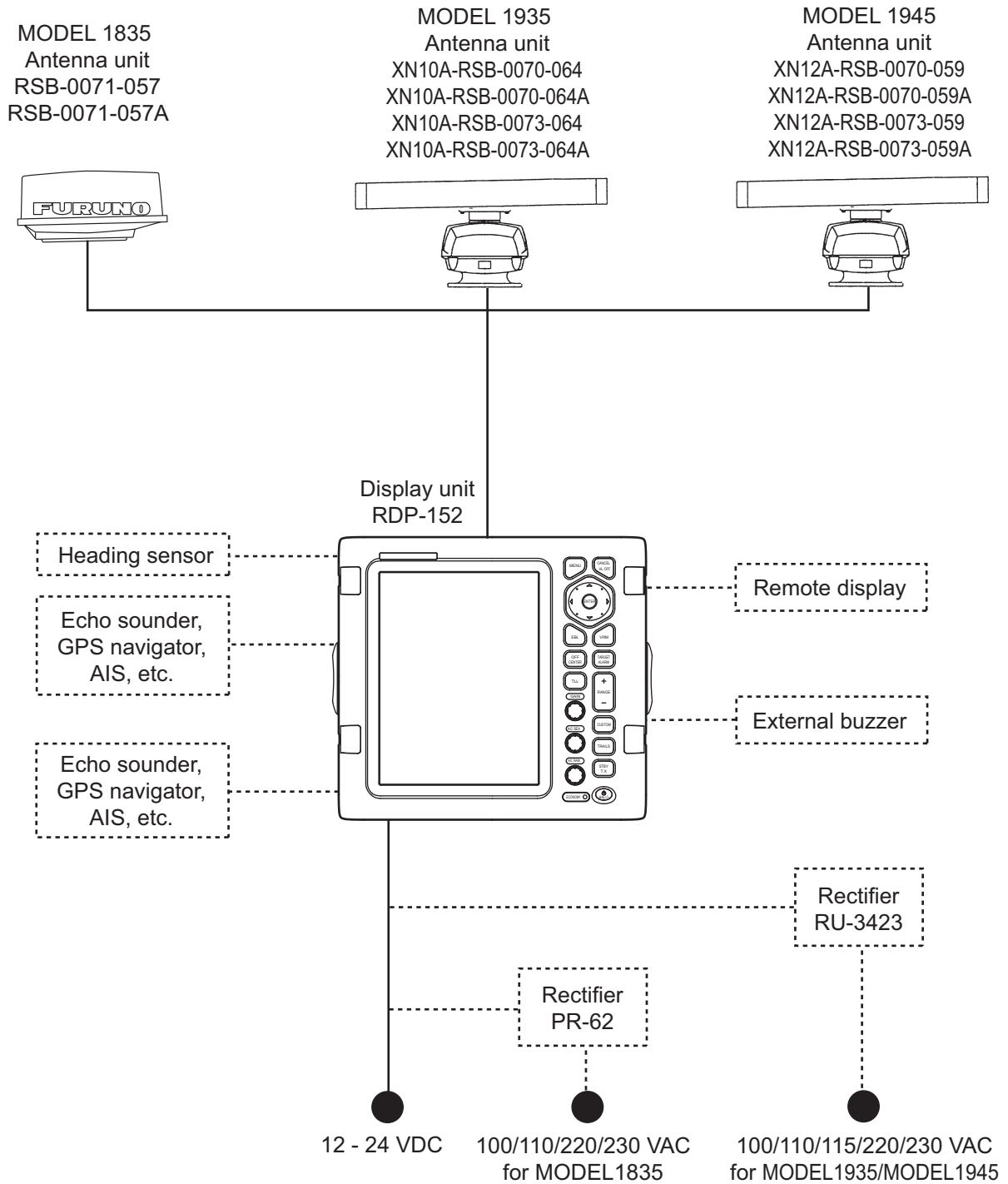

1. DESCRIPTION OF OPERATION

1.1 Controls

Display unit

The display unit has 16 keys which have labels with their functions, three knob controls and a Cursorpad. When you correctly operate this equipment, the unit beeps one time. If your operation is wrong, the unit beeps three times.

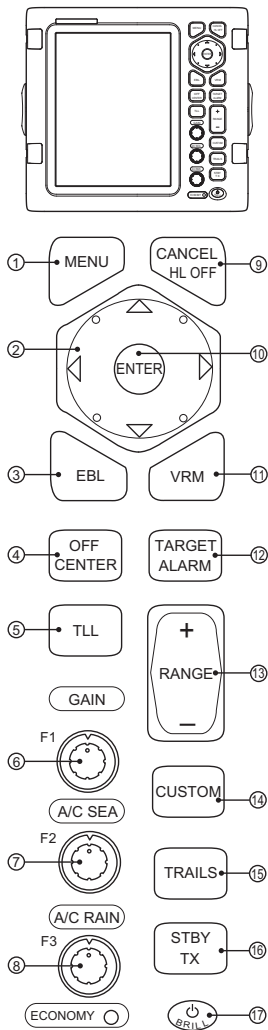

No.	Control	Description
1	MENU	Open/close the menu.
2	Cursorpad	Select the menu items and options. Move the cursor.
3	EBL	Measure the bearing to a target.
4	OFF CENTER	Off-center the display.
5	TLL	Send the latitude and longitude position of a target to a navigation plotter. Enter an origin mark at the cursor position on the radar display.
6	GAIN	Rotating: Adjust the sensitivity of the radar receiver.
7	A/C SEA	Rotating: Reduce the sea clutter.
8	A/C RAIN	Rotating: Reduce the rain clutter.
6, 7, 8	F1, F2, F3	Push: Activate the function given to the key.
9	CANCEL/ HL OFF	Erase the heading line while you press this key. Cancel last entry in menu operation. Cancel the tracking of ARPA target. Remove data of selected ARPA or AIS target from the data box. Return one layer in multiple level menu.
10	ENTER	Save selected menu option. Acquire ARPA target. Select ARPA or AIS target to display its data.
11	VRM	Measure the range to a target.
12	TARGET ALARM	Set the target alarm, which checks for targets in the operator-set area.
13	RANGE	Select the detection range.
14	CUSTOM	Preset the radar controls for one-touch operation of radar.
15	TRAILS	Plot the radar echo movement.
16	STBY/TX	Transmit the radar pulses and put the radar in standby alternately.
17	BRILL	Short press: Turn on the power. Adjust the brilliance. Long press: Turn off the power.

1.2 How to Turn the Radar On/Off and Transmit

Press the  key to turn on the radar. To turn off the radar, press and hold down the key until the screen turns off.

When you turn on the power, the initialization screen appears followed by the start-up screen. The start-up screen shows the model name, program number and the results of the ROM and RAM check, OK or NG (No Good). If NG appears, contact your dealer for instruction.

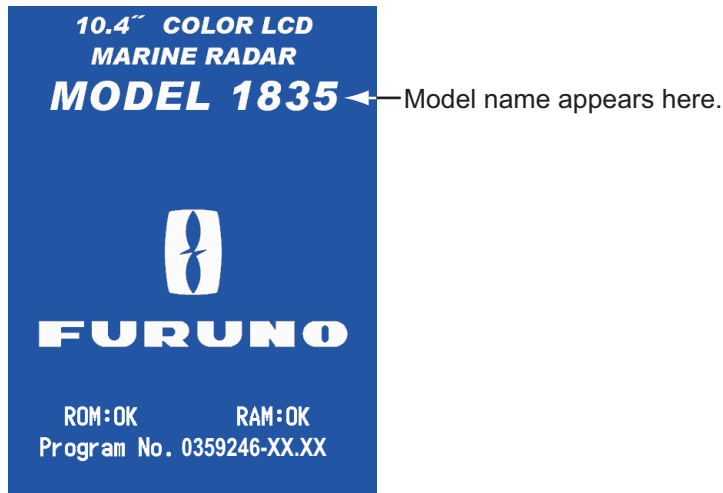

XX: Program version no.



Start-up screen

After the self-tests are completed, the bearing scale and a digital timer appear. The digital timer counts down time necessary to warm the magnetron, which transmits the radar pulses. The time to warm the magnetron takes 90 sec.

After the timer reads 0:00, the STBY screen appears. The STBY screen has three types. (See section 1.44.2.) The radar is ready to transmit the radar pulses. Press the **STBY/TX** key to transmit the radar pulses.

The **STBY/TX** key switches between standby and transmit. The antenna rotates in transmit and is stopped in standby. The magnetron gets old with use. To increase the life of the magnetron, set the radar in standby when you do not use the radar.

Quick start

If the magnetron is still warm, you can get the radar to TRANSMIT without the warm-up time. When the  key is turned off by accident, turn on the  key within 10 seconds after you turn off the power.

1.3 Display Indications

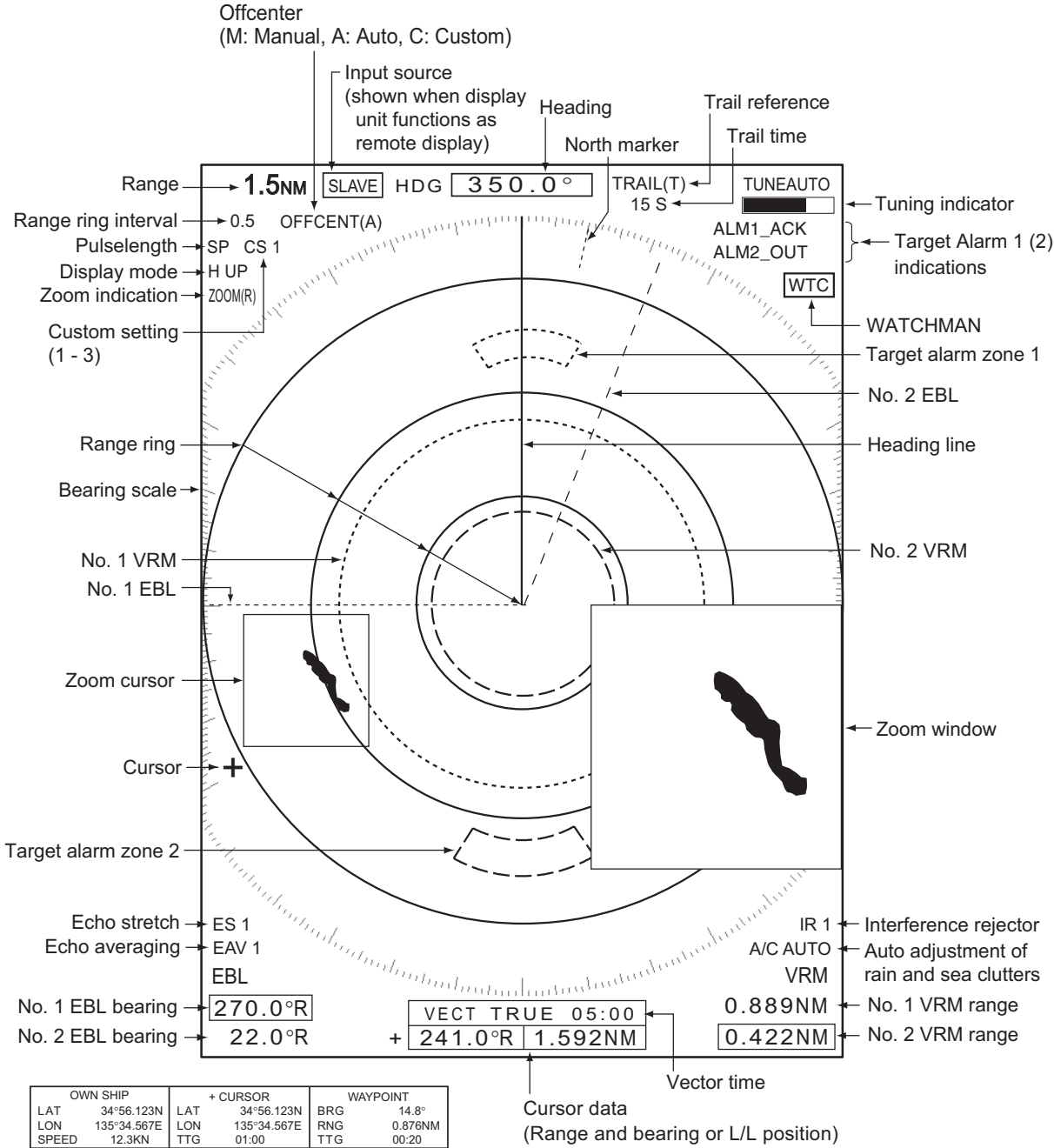

Nav data: Appears at screen bottom when [Data Box] in the [Display] menu is set to [Nav] or [All]. Appropriate sensors required to display nav data.

Display indications

1.4 How to Adjust Display Brilliance, Panel Dimmer

You can adjust the display brilliance and panel dimmer as follows:

1. Press the  key momentarily to show the [Brill/Panel] dialog box.

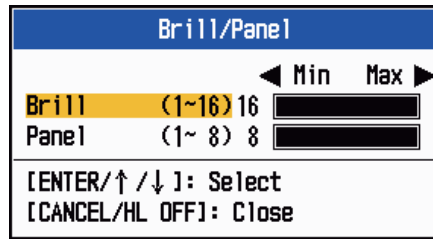

Brill/Panel dialog box

2. Press the **ENTER** key (or ▲, ▼) to select [Brill] or [Panel].
3. Use the Cursorpad (◀ or ▶) to adjust. (For brilliance, you can also use the  key.)
4. Press the **CANCEL/HL OFF** key to close the window.

1.5 Menu Description

This MODEL 1835 series has 15 menus and 6 sub menus. Below is the basic procedure for menu operation.

1. Press the **MENU** key to open the menu.

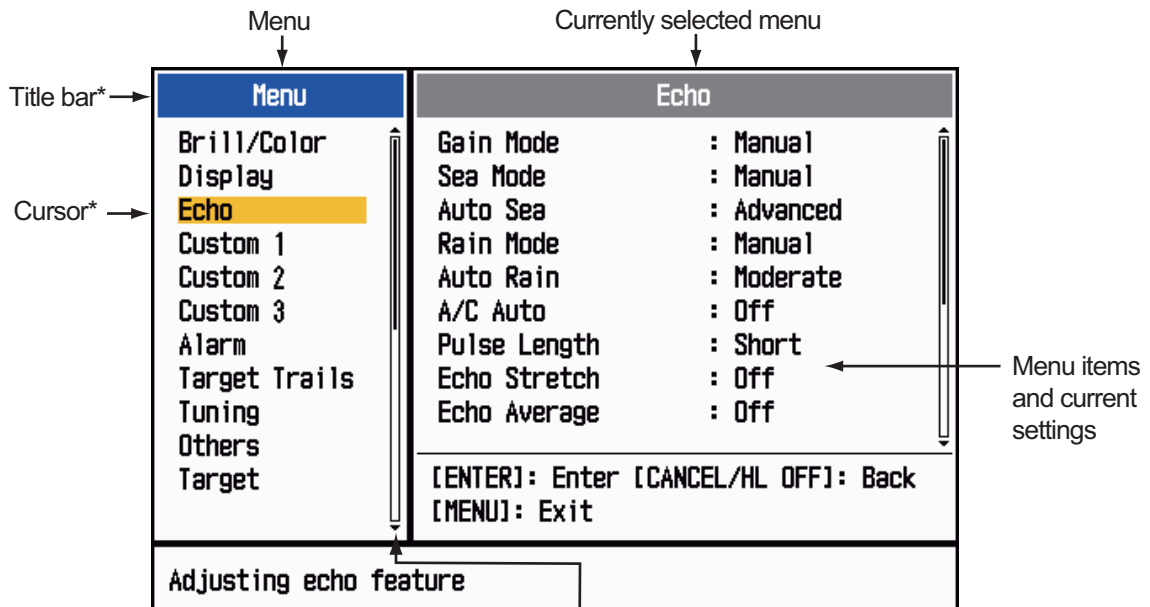

Guide message
(The simple explanation for the current menu.)

Scroll bar (Indicates menus currently not shown in menu window. Black vertical line indicates location in menu. You can see the menus and sub menus currently not shown by using ▲ or ▼.)

*: Title bar in currently controllable column is blue; selected cursor is yellow.
Title bar of inactive column is gray.

Menu

- Use the Cursorpad (▲ or ▼) to select a menu or a sub menu. The cursor (yellow) in the Menu column indicates the menu currently selected. The menu items in the right window change according to the menu selected.

Menu description

[Brill/Color]: Adjust the brilliance and color.

[Display]: Set up the display-related features.

[Echo]: Adjust the echo feature.

[Custom 1] - [Custom 3]: Customize the user settings.

[Alarm]: Set up the alarm items.

[Target Trails]: Process trails of the radar targets.

[Tuning]: Adjust the radar tuning.

[Others]: Set up other items.

[Target]: Set up the targets configuration.

[ARPA]: Set up ARPA targets.

[AIS]: Set up AIS targets.

[GPS]: Set up GP-320B (Black-Box GPS).

[System]

[Initial]: Initial settings.

[Tests]: System diagnostic and LCD test.

[Sector Blanks]: Set up the sector blanks to prevent the transmission in a certain area.

[Units]: Set up units.

[Installation] and [Factory]: For use by the installer. See the Installation Manual.

- Press the **ENTER** key to switch the control to the menu items column. The cursor in the menu column now turns gray and the cursor in the menu items column is yellow. The control moves to the menu items column.
To switch the control from the menu items column to the menu column, use the **CANCEL/HL OFF** key. The color of the title bar of the active column is blue and of the inactive column is gray.
- Use the Cursorpad (▲ or ▼) to select a menu item and press the **ENTER** key. A window with options for the related menu item appears.



Display Color options

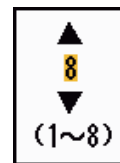

Echo Brill setting window

Example windows

- Use the Cursorpad (▲ or ▼) to select an option or numeric value.
- Press the **ENTER** key to save your selection. To close the window without saving, press the **CANCEL/HL OFF** key (instead of the **ENTER** key).
- Press the **MENU** key to close the menu.

Note: The menus on the [IEC] and [Russian-River] types close automatically when there is no menu operation for 10 seconds, according to IEC regulations. The following menus and screens are excluded from this regulation: Alarm message, Alarm status, Tuning Init Adjust, GPS self test, GPS satellite monitor, System self test, System LCD pattern, and Auto installation setup. The menus do not close automatically in the [River] or [Sea] configuration.

1.6 Tuning

In default, the radar receiver can be tuned automatically after turning the radar to TX. If you require fine tuning in manual, do the following:

1. Transmit the radar and select the maximum range with the **RANGE** key.
2. Press the **MENU** key to open the menu.
3. Use the Cursorpad (▲ or ▼) to select [Tuning] and press the **ENTER** key.

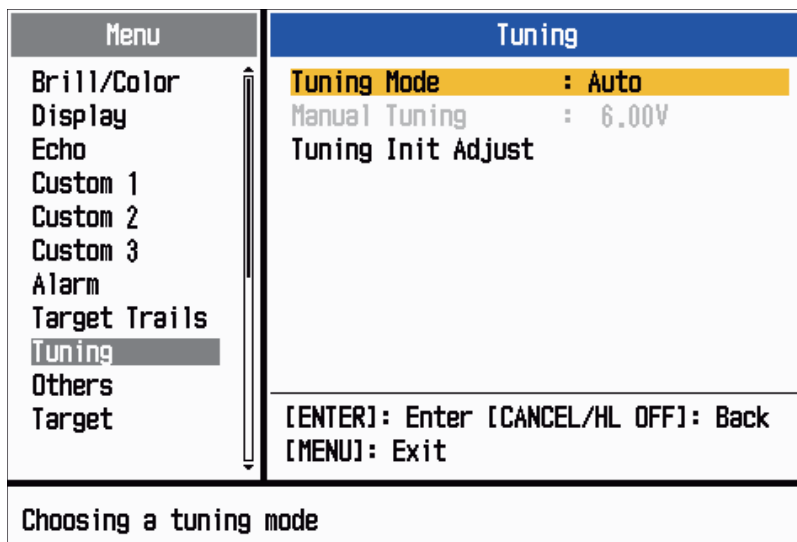

Tuning menu

4. Use the Cursorpad (▲ or ▼) to select [Tuning Mode] and press the **ENTER** key.



Tuning Mode options

5. Use the Cursorpad (▲ or ▼) to select [Manual] and press the **ENTER** key.
6. Use the Cursorpad (▲ or ▼) to select [Manual Tuning] and press the **ENTER** key. The window shown below appears.

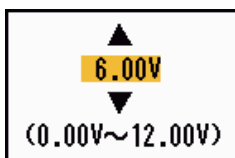

Manual Tuning setting window

7. Use the Cursorpad (▲ or ▼) to adjust the tuning while you look the tuning bar at the upper-right corner of the display. The best tuning point is where the tuning bar moves to maximum value. The vertical bar on the tuning bar shows the tuning voltage.

TUNE MAN ← Tuning method (Manual)

← Tuning bar

← Vertical bar
8. Press the **ENTER** key.
9. Press the **MENU** key to close the menu.

Note: If the automatic tuning does not give the correct tuning, run the [Tuning Init Adjust] again.

1.7 Display Modes

This radar has the display modes shown below. All modes except head-up require a heading signal. The true motion mode additionally requires position data.

Relative Motion (RM)

- [Head Up] (H UP)
- [Course Up] (C UP)
- [North Up] (N UP)
- [True View] (TRUE VIEW)

True Motion (TM)

- [True Motion] (TM)

1.7.1 How to select the display mode

1. Press the **MENU** key to open the menu.
2. Use the Cursorpad (▲ or ▼) to select [Display] and press the **ENTER** key.

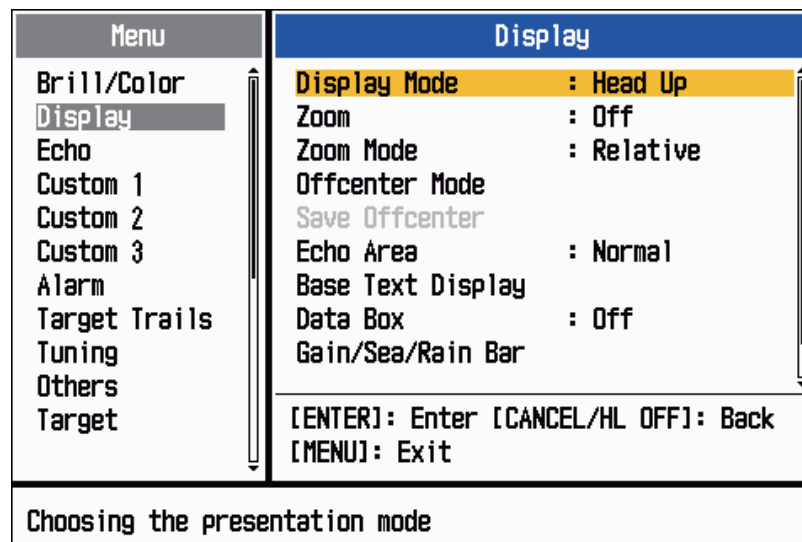

Display menu

3. Use the Cursorpad (▲ or ▼) to select [Display Mode] and press the **ENTER** key.

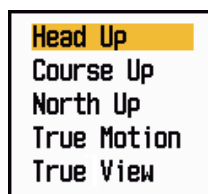

Display Mode options

4. Use the Cursorpad (▲ or ▼) to select a display mode and press the **ENTER** key.
5. Press the **MENU** key to close the menu.

Note: All modes except head-up require a heading signal in AD-10 format or NMEA format. If the heading signal is lost, the mode is changed to head-up and the north marker disappears. The display for heading is XXX.X and the alarm sounds. The message "GYRO" (AD-10 format data) or "NMEA_HDG" (NMEA format data) appears in

1. DESCRIPTION OF OPERATION

the alarm message display. To stop the audio alarm, press any key. When the heading signal is restored, check the heading. To check the heading, press the **F3** key. The numeric value is displayed at the heading indication when the heading signal is restored.

1.7.2 Description of display modes

Head-up mode

A display without azimuth stabilization in which the line that connects the center with the top of the display indicates your heading. Targets are shown at their measured distances and their directions relative to your heading. The short dotted line on the bearing scale is the north marker.

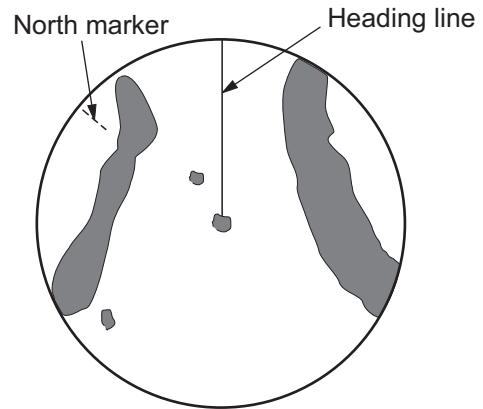

Course-up mode

The radar picture is stabilized and displayed with the currently selected course at the top of the screen. When you change the heading, the heading line moves with the course selected. If you select a new course, select the course-up mode again to display the new course at the top of the display.

Targets are shown at their measured distances and their directions relative to the set course, which is at the 0-degree position. The heading line moves according to the yawing and any course change.

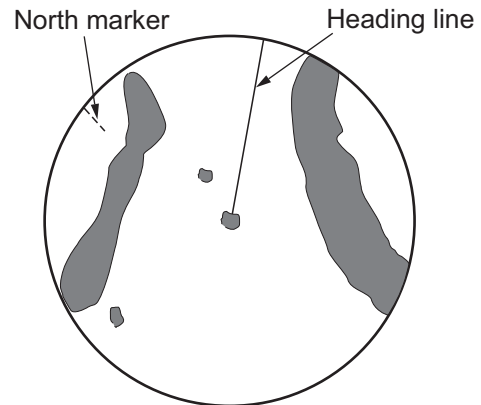

North-up mode

Targets are shown at their measured distances and their true (compass) directions from your ship. North is at the top of the screen. The heading line changes its direction according to your heading.

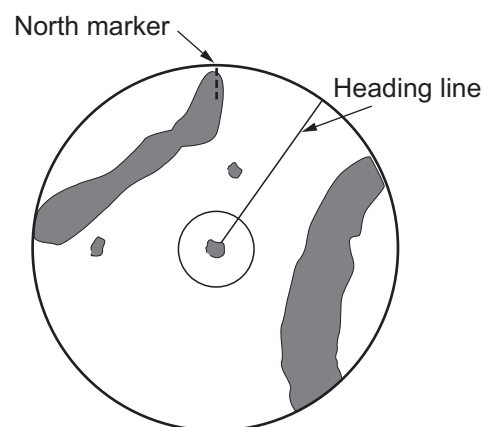

True motion mode

Your ship and other objects in motion move with their true courses and speed. All fixed targets, like landmasses, appear as fixed echoes in ground stabilized TM.

When your ship reaches a point that is 75% of the radius of the display, the position is reset. The ship appears at 75% radius opposite to the extension of the heading line on the display center. You can manually reset your ship symbol if you press the **OFF CENTER** key.

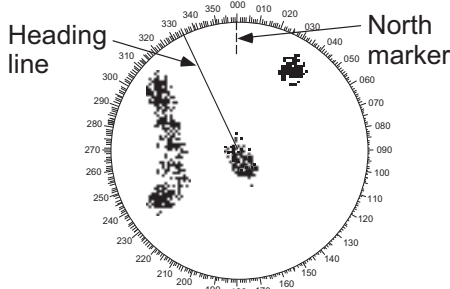
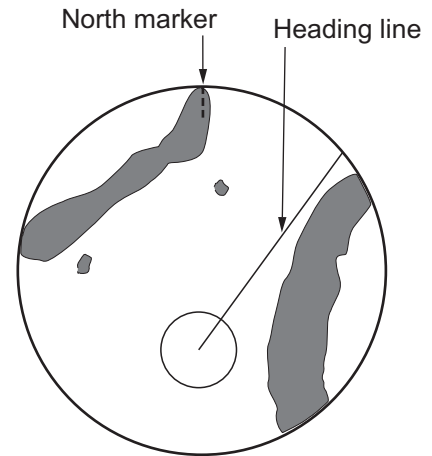

(a) True motion is selected

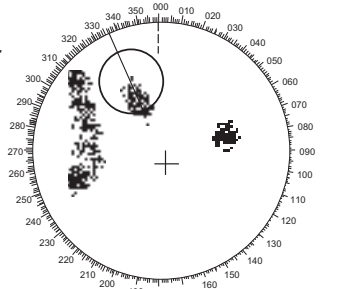

(b) Your ship has reached a point 75% of display radius

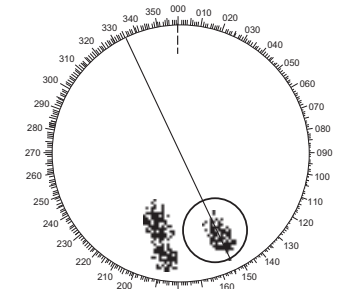

(c) Your ship is automatically reset to 75% of display radius

Automatic reset of your ship marker in true motion mode

True view mode

The echoes move in real time depending on the change of the heading of your ship. Heading line is at the top of the screen. When the heading signal is lost, this function is not available and the display mode automatically changes to the head-up mode. The [Wiper] is not available in this mode (see section 1.31).

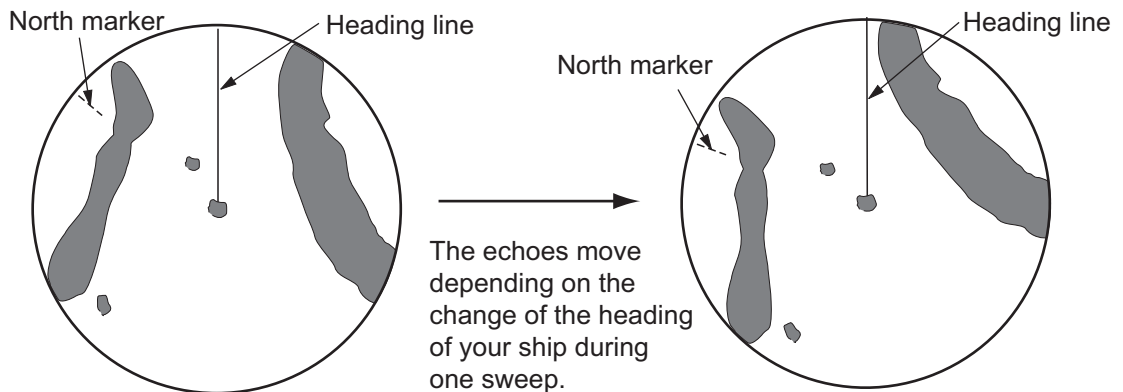

1.8 How to Select a Range Scale

The selected range scale, range ring interval and pulselength are shown at the upper-left corner on the screen. When an objective target comes closer, reduce the range scale so that a target appears in 50-90% of the display radius.

Use the **RANGE** key to select range. Press the "+" part of the key to raise the range; the "-" part to lower the range.

1.9 How to Adjust the Gain (sensitivity)

The gain functions to adjust the sensitivity of the receiver for the best reception. The gain can be adjusted automatically or manually.

1. Press the **MENU** key to open the menu.
2. Use the Cursorpad (▲ or ▼) to select [Echo] and press the **ENTER** key.
3. Use the Cursorpad (▲ or ▼) to select [Gain Mode] and press the **ENTER** key.



Gain Mode options

4. Use the Cursorpad (▲ or ▼) to select [Auto] or [Manual] then press the **ENTER** key. The window for Gain/Sea/Rain indicator shown below appears. This window closes automatically in the [River] or [Sea] mode when there is no menu operation for three seconds. [Auto] is for adjusting the gain automatically. For [Manual], go to **Manual mode** below.

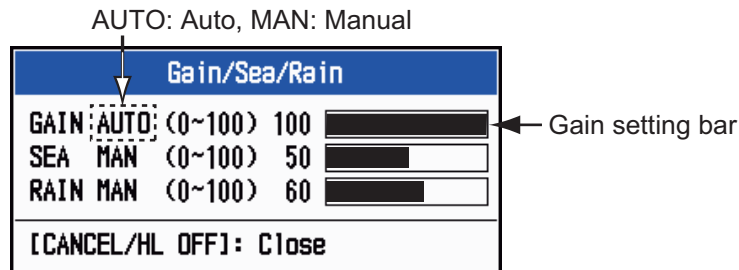

Gain/Sea/Rain indicator

5. Press the **CANCEL/HL OFF** key to close the window.
6. Press the **MENU** key to close the menu.

Note: When you want to adjust the gain finely in [Auto] mode, rotate the **GAIN** knob. The confirmation message appears. If you select [Yes], the mode changes to [Manual] mode. Rotate the **GAIN** knob to adjust the gain.

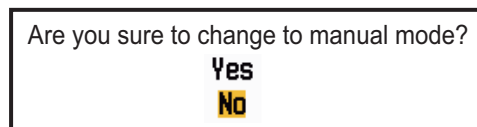

Confirmation message

Manual mode

1. Rotate the **GAIN** knob to adjust the gain so that weak noise appears on all of the screen. If the gain is too low, weak echoes are erased. If the gain is too high, the background noise hides weak targets.
2. Press the **CANCEL/HL OFF** key to close the window.

1.10 How to Reduce the Sea Clutter

The reflected echoes from the waves appear around your ship and have the name "sea clutter". The sea clutter extends according to the height of waves and antenna above the water. When the sea clutter hides the targets, use the **A/C SEA** control to reduce the clutter, either manually or automatically.

1. Press the **MENU** key to open the menu.
2. Use the Cursorpad (▲ or ▼) to select [Echo] and press the **ENTER** key.
3. Use the Cursorpad (▲ or ▼) to select [Sea Mode] and press the **ENTER** key.
4. Use the Cursorpad (▲ or ▼) to select [Auto] or [Manual] then press the **ENTER** key. The window for Gain/Sea/Rain indicator appears (refer to the illustration at step 4 in section 1.9). If you selected [Auto], go to step 5. For [Manual], go to **Manual mode** below.
5. Press the **CANCEL/HL OFF** key to close the window. [Auto] is for reducing the sea clutter automatically. If the sea clutter is strong while cruising along a coastline in the [Auto] mode, go to step 6. If not, go to step 9.
6. Use the Cursorpad (▲ or ▼) to select [Auto Sea] and press the **ENTER** key.



Auto Sea options

7. Use the Cursorpad (▲ or ▼) to select [Coastal] or [Advanced] then press the **ENTER** key. The window for Gain/Sea/Rain indicator appears for confirmation.
 - [Coastal]:** Suppress both land and sea clutter. For cruising along a coastline.
 - [Advanced]:** Automatically discriminate land echoes from sea reflections to suppress only sea reflections. Use this mode for general use.
8. Press the **CANCEL/HL OFF** key to close the window.
9. Press the **MENU** key to close the menu.

Note: When you want to adjust the sea clutter finely in [Auto] mode, rotate the **A/C SEA** knob. The confirmation message appears. If you select [Yes], the mode changes to [Manual] mode. Rotate the **A/C SEA** knob to adjust the sea clutter.

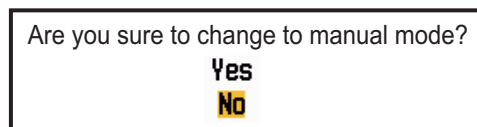

Confirmation message

Manual mode

1. Rotate the **A/C SEA** knob to reduce the sea clutter.
 - Note:** When the setting of the **A/C SEA** control is correct, the clutter is broken into small dots, and small targets become identified. If the setting is not enough, targets are hidden in the clutter. If the setting is higher than necessary, both sea clutter and targets disappear from the display. Normally adjust the control until the clutter has disappeared to leeward, but a small amount of the clutter is visible windward.

1. DESCRIPTION OF OPERATION

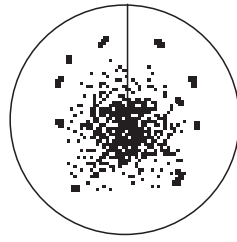

Sea clutter at
screen center

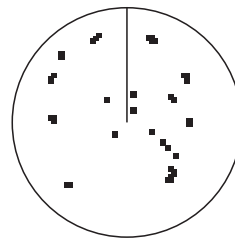

A/C SEA control adjusted;
sea clutter reduced

Sea clutter

2. Press the **CANCEL/HL OFF** key to close the window.

1.11 How to Reduce the Rain Clutter

The reflections from the rain or snow appear on the screen. These reflections have the name "rain clutter". When the rain clutter is strong, targets in the rain clutter are hidden in the clutter. Reflections from the rain clutter are easily identified from true targets by their wool-like appearance.

The **A/C RAIN** control, like the **A/C SEA** control, adjusts the receiver sensitivity, but in longer range. If the setting is high, the rain clutter is more reduced. The rain control breaks the continuous display of rain or snow reflections into a random pattern. When the rain clutter hides the targets, adjust the rain control (automatic or manual) to reduce the clutter.

1. Press the **MENU** key to open the menu.
2. Use the Cursorpad (**▲** or **▼**) to select [Echo] and press the **ENTER** key.
3. Use the Cursorpad (**▲** or **▼**) to select [Rain Mode] and press the **ENTER** key.
4. Use the Cursorpad (**▲** or **▼**) to select [Auto] or [Manual] then press the **ENTER** key. The window for Gain/Sea/Rain indicator appears (refer to the illustration of step 4 at section 1.9). If you selected [Auto], go to step 5. For [Manual], go to **Manual mode** below.
5. Press the **CANCEL/HL OFF** key to close the window.
6. Use the Cursorpad (**▲** or **▼**) to select [Auto Rain] and press the **ENTER** key.



Auto Rain options

7. Use the Cursorpad (**▲** or **▼**) to select [Calm], [Moderate] or [Rough] then press the **ENTER** key. The window for Gain/Sea/Rain indicator appears for confirmation.
[Calm]: For light rain
[Moderate]: When you can not reduce the rain clutter with [Calm] mode
[Rough]: For heavy rain
8. Press the **CANCEL/HL OFF** key to close the window.
9. Press the **MENU** key to close the menu.

Note: When you want to adjust the rain clutter finely in [Auto] mode, rotate the **A/C RAIN** knob. The confirmation message appears. If you select [Yes], the mode changes to [Manual] mode. Rotate the **A/C RAIN** knob to adjust the rain clutter.

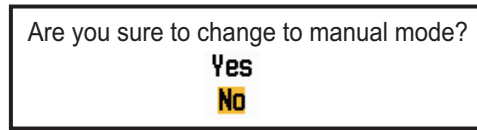

Confirmation message

Manual mode

1. Rotate the **A/C RAIN** knob to reduce the rain clutter.
2. Press the **CANCEL/HL OFF** key to close the window.

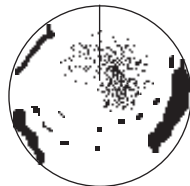

Rain clutter at screen center

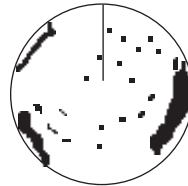

A/C RAIN control adjusted; rain clutter reduced

Rain clutter

1.12 Automatic Adjustments of Sea and Rain Clutters

When you can not correctly reduce the sea clutter or rain clutter with related control, turn on the automatic anti-clutter feature. When this feature is turned on, "A/C AUTO" appears at the lower-right corner.

1. Press the **MENU** key to open the menu.
2. Use the Cursorpad (▲ or ▼) to select [Echo] and press the **ENTER** key.
3. Use the Cursorpad (▲ or ▼) to select [A/C Auto] and press the **ENTER** key.
4. Use the Cursorpad (▲ or ▼) to select [Off] or [On] then press the **ENTER** key.
5. Press the **MENU** key to close the menu.

Caution on use

- [A/C Auto] can lower an echo which covers a wide area, like land or an island.
- When [A/C Auto] is active, the strength of a target in sea clutter or rain clutter can be lower than actual strength. In this case change to manual A/C Sea and manual A/C Rain and adjust the picture.

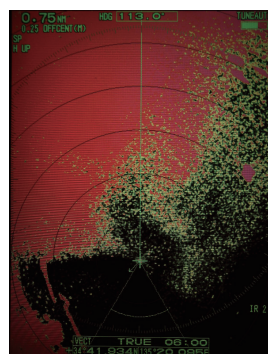

A/C Auto: Off

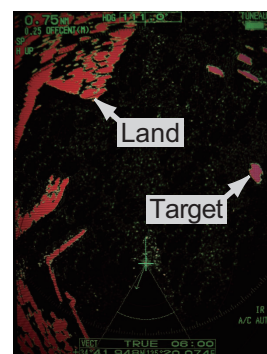

A/C Auto: On

1.13 Cursor

The cursor functions to find the range and bearing (default function) to a target or the latitude and longitude position of a target. Use the Cursorpad to position the cursor and read the cursor data at the screen bottom.

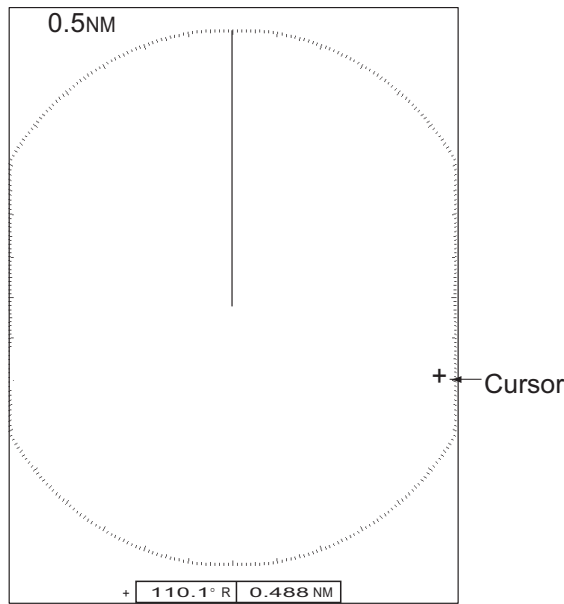

Cursor data
(range and bearing,
or latitude and longitude)

Cursor data

Cursor data

You can show the cursor data as range and bearing (from your ship to the cursor) or latitude and longitude. Position and heading signal are required.

1. Press the **MENU** key to open the menu.
2. Use the Cursorpad (▲ or ▼) to select [Others] and press the **ENTER** key.

Menu	Others
Brill/Color	F1 Setup : Gain Mode
Display	F2 Setup : Sea Mode
Echo	F3 Setup : A/C Auto
Custom 1	WPT Mark : Off
Custom 2	EBL Reference : Relative
Custom 3	VRM Unit : NM
Alarm	Cursor Position : Rng/Brg
Target Trails	
Tuning	
Others	
Target	
[ENTER]: Enter [CANCEL/HL OFF]: Back [MENU]: Exit	
Choosing the function assigned to [F1]	

Others menu

- Use the Cursorpad (▲ or ▼) to select [Cursor Position] and press the **ENTER** key.



Cursor Position options

- Use the Cursorpad (▲ or ▼) to select [Rng/Brg] or [Lat/Lon] then press the **ENTER** key. (When the navigation data is displayed, cursor latitude and longitude position cannot be displayed.)
- Press the **MENU** key to close the menu.

1.14 Interference Rejector

The radar interference can occur when your ship is near the radar of another ship that operates on the same frequency band with your radar. The interference shows on the screen as many bright dots. The dots can be random or in the shape of dotted lines that run from the center to the edge of the display. You can identify the interference from the normal echoes, because the interference does not appear in the same location at the next antenna rotation. When this feature is turned on, "IR 1", "IR 2" or "IR 3" appears at the lower-right corner.

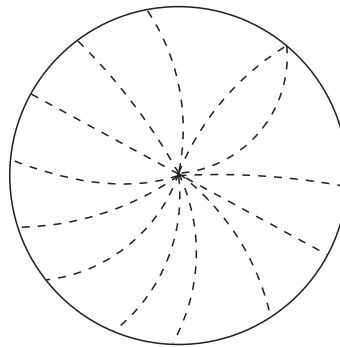

Interference

- Press the **MENU** key to open the menu.
- Use the Cursorpad (▲ or ▼) to select [Echo] and press the **ENTER** key.
- Use the Cursorpad (▲ or ▼) to select [Int Rejector] and press the **ENTER** key.

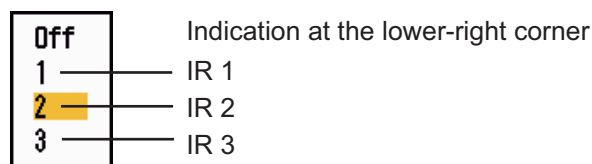

Int Rejector options

- Use the Cursorpad (▲ or ▼) to select [Off], [1], [2] or [3] then press the **ENTER** key. [3] removes the interference the most.
- Press the **MENU** key to close the menu.

Note: When there is no interference, turn off the interference rejector so you do not miss the small targets.

1.15 How to Measure the Range to a Target

You can measure the range to a target in three methods. You can use the fixed range rings, the cursor (if set to measure range and bearing), and the VRM (Variable Range Marker).

Use the fixed range rings to get a rough estimate of the range to a target. The fixed range rings are the concentric solid circles about your ship. The number of rings changes with the selected range scale. The interval of the range ring is displayed at the upper-left corner of the screen. Count the number of rings between the center of the display and the target. Check the range ring interval and measure the distance of the echo from the nearest ring.

1.15.1 How to adjust range ring brilliance

1. Press the **MENU** key to open the menu.
2. Use the Cursorpad (▲ or ▼) to select [Brill/Color] and press the **ENTER** key.

Menu	Brill/Color
Brill/Color	Echo Brill : 8
Display	Rings Brill : 4
Echo	Mark Brill : 4
Custom 1	HL Brill : 4
Custom 2	Character Brill : 4
Custom 3	View Position : Center
Alarm	Display Color : Custom
Target Trails	Echo Color : Yellow
Tuning	Background Color : Black
Others	[ENTER]: Enter [CANCEL/HL OFF]: Back
Target	[MENU]: Exit

Adjusting echo brilliance

Brill/Color menu

3. Use the Cursorpad (▲ or ▼) to select [Rings Brill] and press the **ENTER** key.

Off
1
2
3
4

Rings Brill options

4. Use the Cursorpad (▲ or ▼) to select an option and press the **ENTER** key. [4] is the brightest. [Off] turns off the range rings.
5. Press the **MENU** key to close the menu.

1.15.2 How to measure the range with a VRM

There are two VRMs, No. 1 and No. 2. The VRMs are dashed rings so that you can identify the rings from the fixed range rings. You can identify VRM 1 from VRM 2 by different lengths of dashes. The dashes of the No. 1 VRM are shorter than those of the No. 2 VRM.

1. Press the **VRM** key to display either of the VRMs. Press the **VRM** key to change the active VRM between No. 1 and No. 2. The indication of the currently active VRM is in a rectangle.
2. Use the Cursorpad to align the Variable Range Marker with the inner edge of the target. Read the distance at the lower-right corner of the screen. Each VRM remains at the same geographical distance when you operate the **RANGE** key. The size of the VRM ring changes in proportion to the selected range scale.
3. Press the **ENTER** key to anchor the VRM.
4. To erase a VRM, press the **VRM** key to activate the VRM and press the **CANCEL/HL OFF** key.

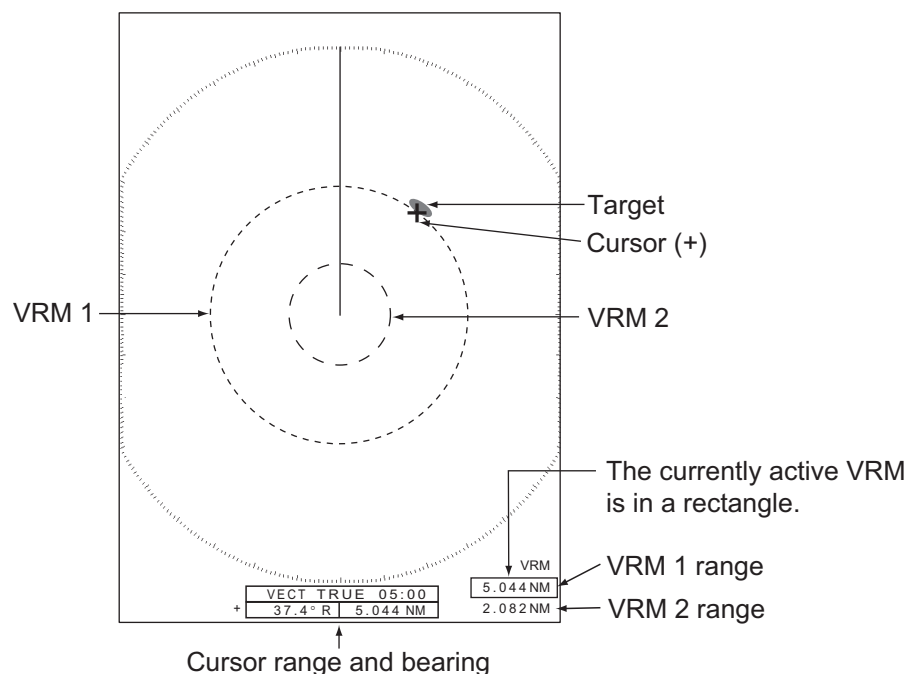

How to measure the range with the VRM

1.15.3 How to select VRM unit

You can select the unit of measurement used by the VRM. The selections are nautical miles (NM), kilometers (KM), statute miles (SM) or kiloyard (KYD). The cursor range unit is also changed when the VRM unit is changed.

1. Press the **MENU** key to open the menu.
2. Use the Cursorpad (**▲** or **▼**) to select [Others] and press the **ENTER** key.

1. DESCRIPTION OF OPERATION

- Use the Cursorpad (▲ or ▼) to select [VRM Unit] and press the **ENTER** key.

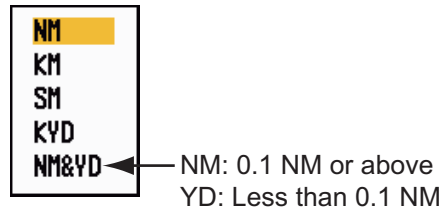

VRM Unit options

- Use the Cursorpad (▲ or ▼) to select the unit and press the **ENTER** key.
- Press the **MENU** key to close the menu.

1.16 How to Measure the Bearing to a Target

Use the Electronic Bearing Line (EBL) to take a bearing of a target. There are two EBLs, No. 1 and No. 2. Each EBL is a straight dashed line from the center of the screen to the edge. The dashes of the No. 1 EBL are shorter than those of the No. 2 EBL.

1.16.1 How to measure the bearing with an EBL

- Press the **EBL** key to display either of the EBLs. Press the **EBL** key to change the active EBL between No. 1 and No. 2. The indication of the currently active EBL is in a rectangle.
- Use the Cursorpad to put the EBL on the center of the target. Read the bearing at the lower-left corner of the screen.
- Press the **ENTER** key to anchor the EBL.
- To erase an EBL, press the **EBL** key to activate the EBL and press the **CANCEL/HL OFF** key.

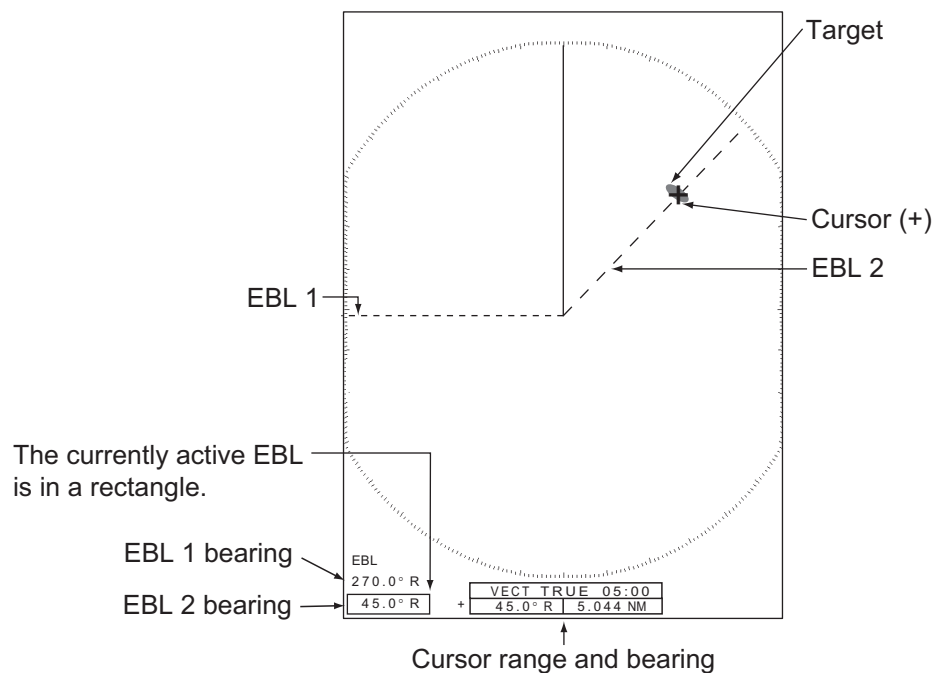

How to measure the bearing with the EBL

1.16.2 EBL reference

"R" (relative) follows the EBL indication if the bearing is relative to the heading of your ship. "T" (true) follows the EBL indication if the bearing is in reference to the north. You can select relative or true in the head-up and true view modes. The bearing indication is true in all other modes. True bearing requires a heading sensor.

1. Press the **MENU** key to open the menu.
2. Use the Cursorpad (▲ or ▼) to select [Others] and press the **ENTER** key.
3. Use the Cursorpad (▲ or ▼) to select [EBL Reference] and press the **ENTER** key.

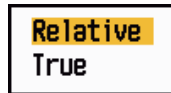

EBL Reference options

4. Use the Cursorpad (▲ or ▼) to select [Relative] or [True] then press the **ENTER** key.
5. Press the **MENU** key to close the menu.

1.17 How to Measure the Range and Bearing Between Two Targets

You can move the origin of the EBL to measure the range and bearing between two targets.

1. Press the **EBL** key to select the bearing indication of EBL 1 or EBL 2. The indication of the currently active EBL is in a rectangle.
2. Use the Cursorpad to put the cursor on the center of the target A.
3. Press the **OFF CENTER** key to move the origin of the EBL to the location selected at step 2.
4. Use the Cursorpad to put the cursor on the center of the target B.
5. Press the **VRM** key to display the VRM having the same number as the EBL activated at step 1. The indication of the currently active VRM is in a rectangle.
6. Use the Cursorpad to set the VRM on the inner edge of the target B.

1. DESCRIPTION OF OPERATION

7. Read the bearing and range indications at the bottom of the screen.

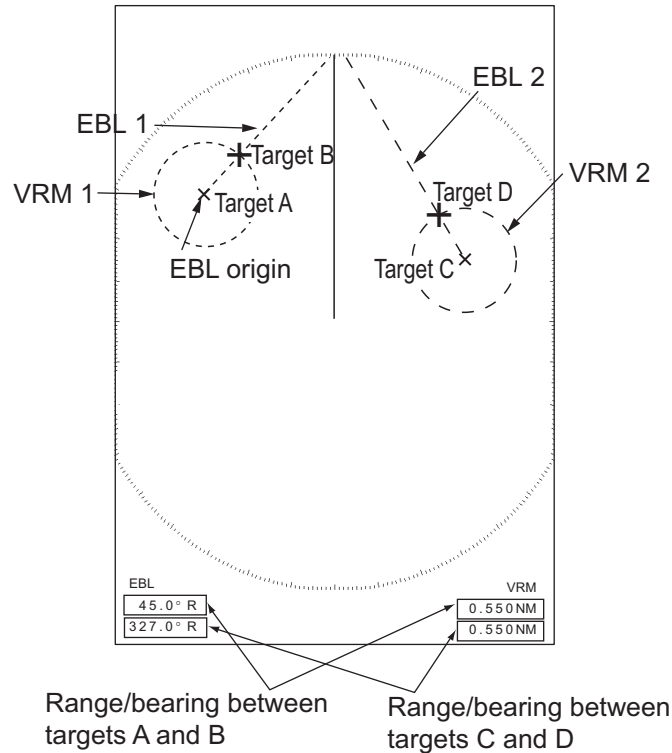

How to measure the range and bearing between two targets

When you press the **OFF CENTER** key in EBL operation, the origin of an EBL moves between the screen center and cursor location. To return the origin of an EBL to the screen center, press the **ENTER** key when the origin of an EBL is on the screen center.

1.18 How to Select a Pulselength

The pulselength in use appears at the upper-left position on the screen. The pulselengths are set to each range scale and custom setup. You can change the pulselength on the 1.5 nm, 1.6 nm, 3 nm or 3.2 nm range with the following procedure. Pulselength cannot be changed on other ranges. (You can change the pulselength on the 2 nm or 4 nm range in the [Russian-River] mode.) Use a longer pulse when your purpose is long range detection. Use a shorter pulse when the resolution is important.

Note: Press the **CUSTOM** key several times to activate the [Echo] menu until the CS 1 (2, 3) indication (custom setting) disappears from the screen. See the illustration in section 1.3.

1. Press the **MENU** key to open the menu.

- Use the Cursorpad (▲ or ▼) to select [Echo] and press the **ENTER** key.

Menu	Echo
Brill/Color	Gain Mode : Manual
Display	Sea Mode : Manual
Echo	Auto Sea : Advanced
Custom 1	Rain Mode : Manual
Custom 2	Auto Rain : Moderate
Custom 3	A/C Auto : Off
Alarm	Pulse Length : Short
Target Trails	Echo Stretch : Off
Tuning	Echo Average : Off
Others	[ENTER]: Enter [CANCEL/HL OFF]: Back
Target	[MENU]: Exit

Choosing gain adjustment method

Echo menu

- Use the Cursorpad (▲ or ▼) to select [Pulse Length] and press the **ENTER** key.



Pulse Length options

- Use the Cursorpad (▲ or ▼) to select [Short] or [Long] then press the **ENTER** key. The pulselenhth indication at the upper-left corner changes according to your selection as shown below.
 1.5 nm or 1.6 nm (or 2 nm in the [Russian-River] mode): "SP" for [Short] pulse, "MP" for [Long] pulse
 3 nm or 3.2 nm (or 4 nm in the [Russian-River] mode): "MP" for [Short] pulse, "LP" for [Long] pulse
- Press the **MENU** key to close the menu.

1.19 Target Alarm

The target alarm looks for targets (ship, landmass, etc.) in the area you set. Audiovisual alarms are released when a target enters (or exits) the alarm area.

CAUTION
<ul style="list-style-type: none"> • Do not depend on the alarm as the only means to detect possible collision situations. • Adjust the A/C SEA, A/C RAIN and GAIN controls correctly so that the alarm system does not miss the target echoes.

1. DESCRIPTION OF OPERATION

1.19.1 How to set a target alarm zone

The following procedure shows you how to set a target alarm zone.

1. Press the **TARGET ALARM** key to activate ALARM 1 or ALARM 2. Press the **TARGET ALARM** key to change the active ALARM between No. 1 and No. 2. The indication of the currently active ALARM is in a rectangle at the upper-right corner of the screen.
2. Use the Cursorpad to move the cursor to the position A and press the **ENTER** key.
3. Move the cursor to the position B and press the **ENTER** key. The rectangle that shows alarm status indication at the upper-right corner of the screen disappears.

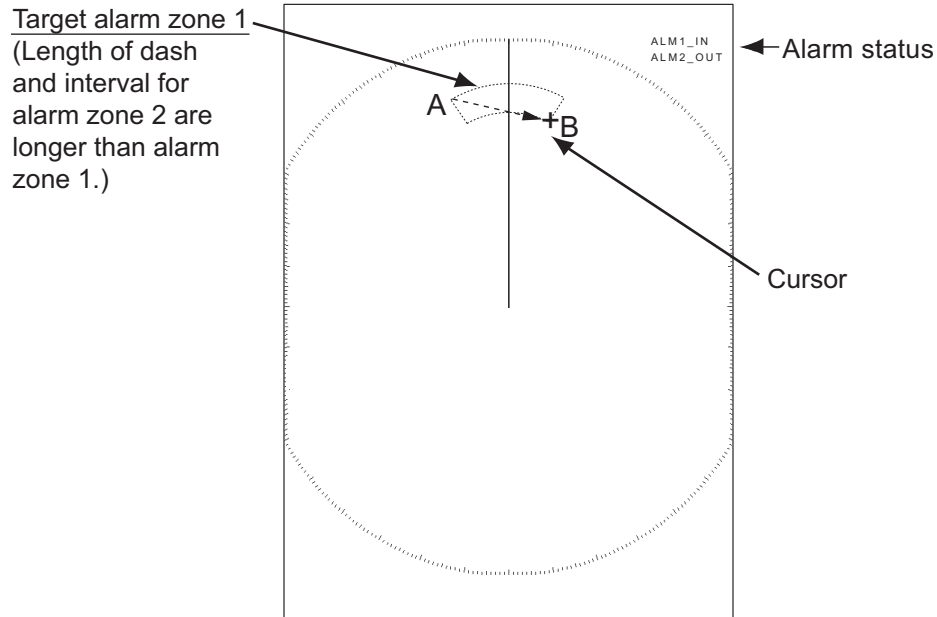

How to set a target alarm zone

Note 1: To set a 360-degree guard zone, set the position B in the same bearing as the position A.

Note 2: When the target alarm zone is not within the range in use, the indication "ALM1(or 2)_RNG" replaces "ALM1(or 2)_IN(or OUT)" in the alarm status area. (When the target alarm zone is within the range of full off-centering, the indication does not change.) Select a range which displays the target alarm zone.

1.19.2 How to stop the audio alarm

When a target enters (or exits) the target alarm zone, the target flashes and the alarm sounds. The alarm message appears at the bottom of the screen. To stop the audio alarm, press any key. When the target enters (or exits) the target alarm zone again, the audio alarm sounds.

1.19.3 How to select the alarm type

You can set the target alarm to activate against targets entering or exiting the alarm zone.

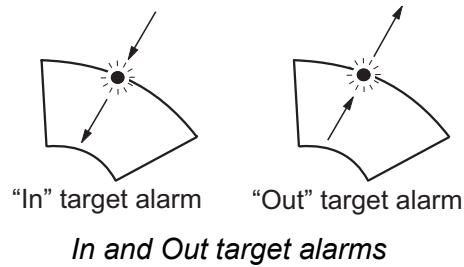

1. Press the **MENU** key to open the menu.
2. Use the Cursorpad (▲ or ▼) to select [Alarm] and press the **ENTER** key.

Menu	Alarm
Brill/Color	Target Alarm 1 : In
Display	Target Alarm 2 : In
Echo	Alarm Level : Med
Custom 1	Watchman : Off
Custom 2	Panel Buzzer : On
Custom 3	External Buzzer : On
Alarm	Alarm Status
Target Trails	
Tuning	
Others	
Target	
[ENTER]: Enter [CANCEL/HL OFF]: Back [MENU]: Exit	
Choosing the type (in/out) of target alarm 1	

Alarm menu

3. Use the Cursorpad (▲ or ▼) to select [Target Alarm 1] or [Target Alarm 2] then press the **ENTER** key.



Target Alarm options

4. Use the Cursorpad (▲ or ▼) to select [In] or [Out].
[In]: When the targets enter a target alarm zone, the alarm sounds.
[Out]: When the targets exit a target alarm zone, the alarm sounds.
5. Press the **ENTER** key followed by the **MENU** key.

1.19.4 How to sleep a target alarm temporarily

When you do not require a target alarm temporarily, you can sleep the target alarm. The alarm zone remains on the screen, but any targets that enter (or exit) the alarm zone do not trigger the audio and visual alarms.

1. Press the **TARGET ALARM** key to select the ALARM 1 or ALARM 2 indication at the upper-right corner on the screen. The selected indication is in a rectangle.

1. DESCRIPTION OF OPERATION

2. Press the **CANCEL/HL OFF** key. The alarm indication now shows "ALM1(or 2)_ACK".

To activate a sleeping target alarm zone, press the **TARGET ALARM** key to select the ALARM 1 or ALARM 2 and press the **ENTER** key. The alarm indication then changes to "ALM1(or 2)_IN(or OUT)".

1.19.5 How to deactivate a target alarm

1. Press the **TARGET ALARM** key to select the ALARM 1 or ALARM 2 indication at the upper-right corner on the screen. The selected indication is in a rectangle.
2. Press the **CANCEL/HL OFF** key. The alarm indication now shows "ALM1(or 2)_ACK".
3. Press the **TARGET ALARM** key. The alarm indication "ALM1(or 2)_ACK" is shown in a dashed-line rectangle.
4. Press the **CANCEL/HL OFF** key. The target alarm zone and the alarm indication are erased from the screen.

1.19.6 How to select the target strength which triggers a target alarm

You can select the target strength which triggers the target alarm as follows:

1. Press the **MENU** key to open the menu.
2. Use the Cursorpad (▲ or ▼) to select [Alarm] and press the **ENTER** key.
3. Use the Cursorpad (▲ or ▼) to select [Alarm Level] and press the **ENTER** key.



Alarm Level options

4. Use the Cursorpad (▲ or ▼) to select the echo strength level.
5. Press the **ENTER** key followed by the **MENU** key.

1.19.7 How to turn the buzzer on/off

You can turn on/off the panel buzzer or external buzzer for target alarms. The panel buzzer is for this equipment. The external buzzer is for the optional buzzer, which is connected to this equipment to give the target alarm at a remote location.

1. Press the **MENU** key to open the menu.
2. Use the Cursorpad (▲ or ▼) to select [Alarm] and press the **ENTER** key.
3. Use the Cursorpad (▲ or ▼) to select [Panel Buzzer] (or [External Buzzer] for optional buzzer) and press the **ENTER** key.



Panel Buzzer and External Buzzer options

4. Use the Cursorpad (▲ or ▼) to select [On] or [Off] then press the **ENTER** key.
5. Press the **MENU** key to close the menu.

1.20 How to Off-center the Display

You can off-center your ship position to expand the view field without selecting a larger range scale. The display can be off-centered manually, or automatically according to speed of the ship.

Note: Off-centering is not available in the true motion mode.

1.20.1 How to select the off-center mode

1. Press the **MENU** key to open the menu.
2. Use the Cursorpad (▲ or ▼) to select [Display] and press the **ENTER** key.
3. Use the Cursorpad (▲ or ▼) to select [Offcenter Mode] and press the **ENTER** key.

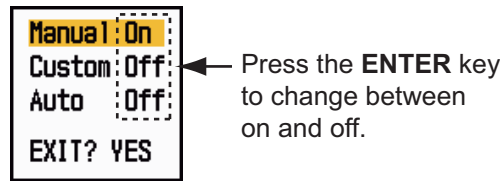

Offcenter Mode options

4. Use the Cursorpad (▲ or ▼) to select [Manual], [Custom] or [Auto] then press the **ENTER** key. Press the **ENTER** key to change between on and off.
5. After setting all options, use the Cursorpad (▼) to select [EXIT? YES] and press the **ENTER** key.
6. Press the **MENU** key to close the menu.

1.20.2 Off-center the display

Press the **OFF CENTER** key to move your ship position. When you press the **OFF CENTER** key continuously, the mode changes in the sequence of OFF → Manual → Custom → Auto → OFF → Manual →... (the options available depend on setting selected at step 4 in section 1.20.1). When off-centering is active, "OFFCENT(M)", "OFFCENT(C)" or "OFFCENT(A)" appears at the upper-left corner on the display.

Note: Off-center is not available on the 64 nm range scale.

Manual (Indication: "OFFCENT(M)")

You can move your ship position to the current cursor position on all modes except true motion, within 75% of the available display area.

1. Press the **OFF CENTER** key several times until the off-center indication disappears.
2. Put the cursor on the position where to off-center the display.
3. Press the **OFF CENTER** key several times until the indication "OFFCENT(M)" appears.

1. DESCRIPTION OF OPERATION

Custom (Indication: "OFFCENT(C)")

You can move your ship position to the position which you pre-set. Follow the procedure shown below to register the cursor position.

1. Press the **OFF CENTER** key several times until the off-center indication disappears.
2. Put the cursor on the position where to off-center the display.
3. Press the **OFF CENTER** key several times until the indication "OFFCENT(M)" appears.
4. Press the **MENU** key to open the menu.
5. Use the Cursorpad (▲ or ▼) to select [Display] and press the **ENTER** key.
6. Use the Cursorpad (▲ or ▼) to select [Save Offcenter] and press the **ENTER** key. The message "Complete" appears.
7. Press any key to close the message window.
8. Press the **MENU** key to close the menu.

To change the mode to custom, press the **OFF CENTER** key several times until the indication "OFFCENT(C)" appears.

Auto (Indication: "OFFCENT(A)")

The amount of automatic move is calculated according to speed of the ship. The maximum amount is 75% of the range in use. The formula to calculate automatic shift is shown below.

$$\frac{\text{Speed of ship}}{\text{Offcenter speed setting}} \times 0.75 = \text{Amount of move (\%)}$$

If the offcenter speed setting is 15 knots and the speed of the ship is 10 knots, for example, the amount of move at the stern of your ship will be 50% of the available display area.

How to select offcenter speed

1. Press the **MENU** key to open the menu.
2. Use the Cursorpad (▲ or ▼) to select [Initial] sub menu in [System] menu and press the **ENTER** key.
3. Use the Cursorpad (▲ or ▼) to select [Offcenter Speed] and press the **ENTER** key.

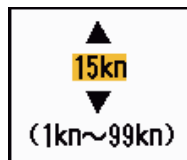

Offcenter Speed setting window

4. Use the Cursorpad (▲ or ▼) to select the speed to use and press the **ENTER** key.
5. Press the **MENU** key to close the menu.

1.21 Zoom

The zoom function expands the length and width of a selected target as much as twice its normal size, in the zoom window. You select the target to zoom with the zoom cursor. The selected target is zoomed in the zoom window.

ARPA and AIS symbols can be displayed in the zoom window, but are not zoomed. You can process ARPA and AIS targets that are in the zoom window, in the same method as on the normal radar display.

There are three types of zoom.

[Relative]: The zoom cursor is fixed to the range and bearing from your ship. **[True]:** The zoom cursor is fixed to set geographical position. **[Target]:** The zoom cursor is fixed to the zoomed AIS or ARPA target.

1.21.1 Zoom mode

You can select the zoom mode from [Relative], [True] or [Target].

1. Press the **MENU** key to open the menu.
2. Use the Cursorpad (▲ or ▼) to select [Display] and press the **ENTER** key.
3. Use the Cursorpad (▲ or ▼) to select [Zoom Mode] and press the **ENTER** key.

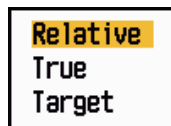

Zoom Mode options

4. Use the Cursorpad (▲ or ▼) to select [Relative], [True] or [Target] then press the **ENTER** key.

Note: True zoom mode requires a heading signal and position data.
5. Press the **MENU** key to close the menu.

1.21.2 How to zoom

Relative or True zoom mode

1. Use the Cursorpad to put the cursor on the position desired.
2. Press the **MENU** key to open the menu.
3. Use the Cursorpad (▲ or ▼) to select [Display] and press the **ENTER** key.
4. Use the Cursorpad (▲ or ▼) to select [Zoom] and press the **ENTER** key.



Zoom options

5. Use the Cursorpad (▲ or ▼) to select [On] and press the **ENTER** key.

The ZOOM indication appears at the upper-left corner on the screen. The zoom window and the zoom cursor also appear (see the illustration on the next page). To quit the zoom, select [Off] instead of [On] and press the **ENTER** key.
6. Press the **MENU** key to close the menu.

1. DESCRIPTION OF OPERATION

Target zoom mode

The ARPA or AIS target as below can be displayed in the zoom window:

ARPA: The symbol is enlarged twice its normal size. AIS: The symbol is enclosed in a broken square. (The symbol is not enlarged.)

The zoom cursor moves with the ARPA or AIS target.

Note: If neither ARPA nor AIS targets are selected, the message "NO TARGET." appears. Press any key to erase the message.

1. Press the **MENU** key to open the menu.
2. Use the Cursorpad (▲ or ▼) to select [Display] and press the **ENTER** key.
3. Use the Cursorpad (▲ or ▼) to select [Zoom] and press the **ENTER** key.
4. Use the Cursorpad (▲ or ▼) to select [On] and press the **ENTER** key.
The ZOOM indication appears at the upper-left corner on the screen. The zoom window and the zoom cursor also appear (see the following illustration). To quit the zoom, select [Off] instead of [On] and press the **ENTER** key.
5. Press the **MENU** key to close the menu.

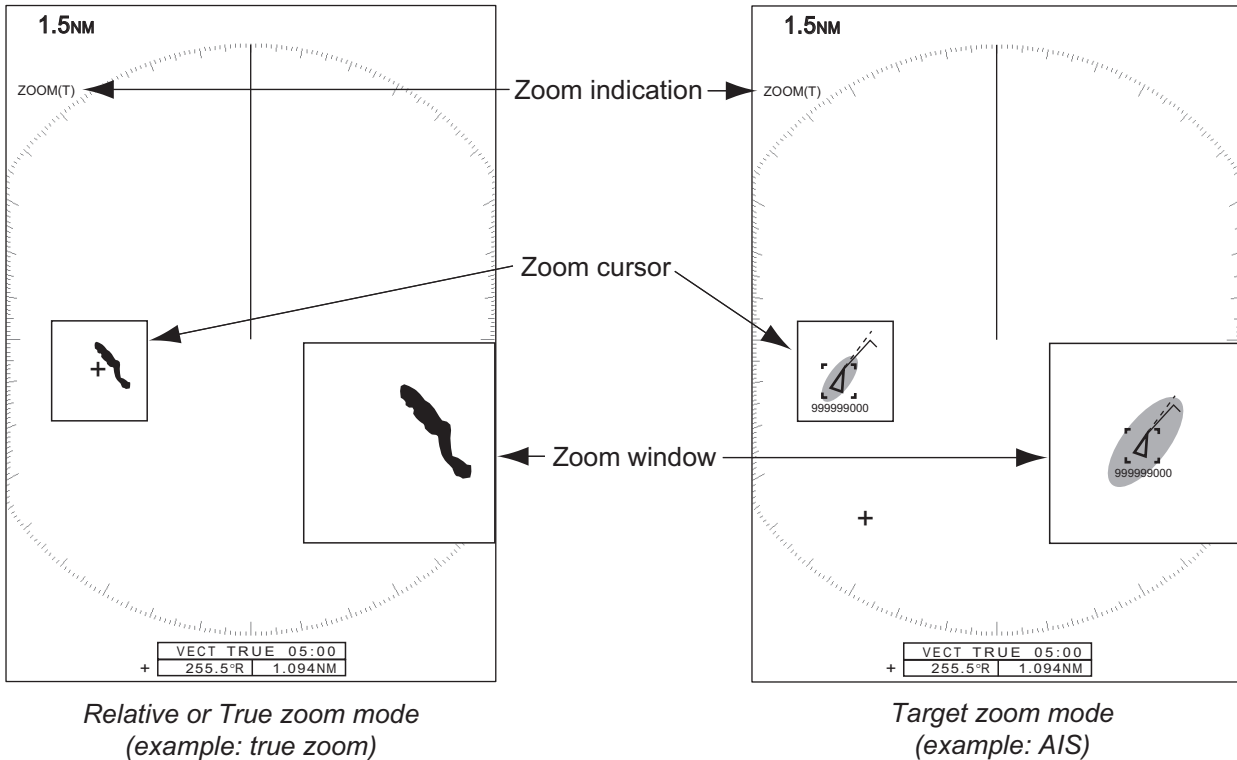

1.22 Echo Stretch

The echo stretch feature enlarges the targets in the range and bearing directions to make the targets easier to see. This feature is available on any range. There are three levels of echo stretch, [1], [2] and [3]. [3] enlarges the targets the most.

Note: The echo stretch magnifies the targets, sea and rain clutters, and radar interference. Correctly adjust the sea clutter, rain clutter and radar interference before you activate the echo stretch.

1. Press the **MENU** key to open the menu.
2. Use the Cursorpad (▲ or ▼) to select [Echo] and press the **ENTER** key.
3. Use the Cursorpad (▲ or ▼) to select [Echo Stretch] and press the **ENTER** key.

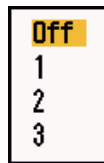

Echo Stretch options

4. Use the Cursorpad (▲ or ▼) to select an echo stretch option and press the **ENTER** key.
5. Press the **MENU** key to close the menu. When the echo stretch is active, "ES 1 (2, or 3)" appears at the lower-left corner on the display.

1.23 Echo Average

To identify true target echoes from the sea clutter, echoes are averaged over successive picture frames. If an echo is solid and stable, the echo is shown in its normal intensity. The brilliance of sea clutter is reduced to easily identify true targets from the sea clutter.

Note 1: Do not use the echo average function under heavy pitching and rolling. You can lose a target.

Note 2: This feature requires a heading signal and position data. When either signal becomes lost, echo average is deactivated.

To correctly use the echo average function, first reduce the sea clutter with the **A/C SEA** control, then do as follows:

1. Press the **MENU** key to open the menu.
2. Use the Cursorpad (▲ or ▼) to select [Echo] and press the **ENTER** key.
3. Use the Cursorpad (▲ or ▼) to select [Echo Average] and press the **ENTER** key.

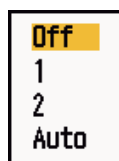

Echo Average options

1. DESCRIPTION OF OPERATION

- Use the Cursorpad (▲ or ▼) to select an echo averaging option and press the **ENTER** key.
[Off]: Deactivate the echo average.
[1]: Identify true targets from the sea clutter and reduce the brilliance of unstable echoes.
[2]: Identify true targets from the sea clutter that you cannot reduce the brilliance with setting 1.
[Auto]: Identify true targets from the sea clutter. Detect far and unstable targets.
- Press the **MENU** key to close the menu. The selected echo average ("EAV 1", "EAV 2" or "EAV(A)") appears at the lower-left corner of the display.

1.24 Target Trails

The trails of the radar targets can be shown simulated in afterglow to check target movement. The target trails are selected for either relative or true. True motion trails require a heading signal and position data.

1.24.1 Trail time

- Press the **MENU** key to open the menu.
- Use the Cursorpad (▲ or ▼) to select [Target Trails] and press the **ENTER** key.
- Use the Cursorpad (▲ or ▼) to select [Time] and press the **ENTER** key.

15s	On
30s	On
1min	On
3min	On
6min	On
15min	On
30min	On
Continuous	On
EXIT? YES	

← Press the **ENTER** key to change between on and off.

Time options

- Use the Cursorpad (▲ or ▼) to select time and press the **ENTER** key. Press the **ENTER** key to change between on and off.
- After setting all options, use the Cursorpad (▼) to select [EXIT? YES] and press the **ENTER** key.
- Press the **MENU** key to close the menu.

1.24.2 How to start, stop the trails

1. Press the **TRAILS** key to start the trails and select the trail time. The selected time with the trail mode is shown at the upper-right corner as in the figure shown below. The available trail time with the **TRAILS** key changes according to trail times, which you turn on in section 1.24.1.

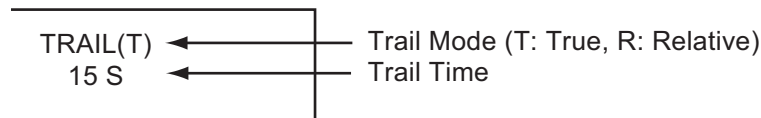

Trail indications

2. To change the trail time, press the **TRAILS** key until the desired trail time is displayed. The trail lengthens with the trail time.

Note 1: To erase the trails, press and hold the **TRAILS** key until a beep sounds, or select [All Cancel] on the [Target Trails].

Note 2: To deactivate the trails, press the **TRAILS** key several times until the trail indications disappear from the display.

1.24.3 Trail mode

You can display the echo trails in true or relative motion.

True mode

The true trails show true target movements according to their over-the-ground speeds and courses. The stationary targets do not show the trails. The true trails require a heading signal and position data.

Relative mode

The relative trails show other ships' movements relative to your ship. The stationary targets also show the trails.



True target trails

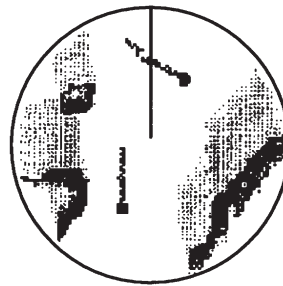

Relative target trails

True trails and relative trails

To select the trail mode, do the following:

1. Press the **MENU** key to open the menu.
2. Use the Cursorpad (▲ or ▼) to select [Target Trails] and press the **ENTER** key.

1. DESCRIPTION OF OPERATION

- Use the Cursorpad (▲ or ▼) to select [Mode] and press the **ENTER** key.



Mode options

- Use the Cursorpad (▲ or ▼) to select [Relative] or [True] then press the **ENTER** key.
- Press the **MENU** key to close the menu.

1.24.4 Trail gradation

Trails can be shown in single or multiple gradation. Multiple gradation fades the gradation over time.

- Press the **MENU** key to open the menu.
- Use the Cursorpad (▲ or ▼) to select [Target Trails] and press the **ENTER** key.
- Use the Cursorpad (▲ or ▼) to select [Gradation] and press the **ENTER** key.

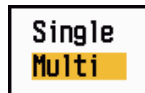

Gradation options

- Use the Cursorpad (▲ or ▼) to select [Single] or [Multi] then press the **ENTER** key.

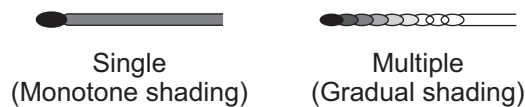

Trail gradation

- Press the **MENU** key to close the menu.

1.24.5 Trail color

You can select the color for trails as follows:

- Press the **MENU** key to open the menu.
- Use the Cursorpad (▲ or ▼) to select [Target Trails] and press the **ENTER** key.
- Use the Cursorpad (▲ or ▼) to select [Color] and press the **ENTER** key.

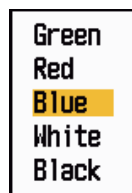

Color options

- Use the Cursorpad (▲ or ▼) to select a color and press the **ENTER** key.
- Press the **MENU** key to close the menu.

1.24.6 Trail level

You can select which target strength to display.

1. Press the **MENU** key to open the menu.
2. Use the Cursorpad (▲ or ▼) to select [Target Trails] and press the **ENTER** key.
3. Use the Cursorpad (▲ or ▼) to select [Level] and press the **ENTER** key.



Level options

4. Use the Cursorpad (▲ or ▼) to select [1], [2] or [3] then press the **ENTER** key.
 - [1]**: Display the trails for all targets (including weak targets).
 - [2]**: Display the trails for medium-to-strong level targets.
 - [3]**: Display the trails for only strong targets.
5. Press the **MENU** key to close the menu.

1.24.7 How to restart, stop the trails

When the range is changed while the trail feature is active, trails within the previous range scale can be stopped and restarted.

1. Press the **MENU** key to open the menu.
2. Use the Cursorpad (▲ or ▼) to select [Target Trails] and press the **ENTER** key.
3. Use the Cursorpad (▲ or ▼) to select [Restart] and press the **ENTER** key.



Restart options

4. Use the Cursorpad (▲ or ▼) to select [Off] or [On] then press the **ENTER** key.
 - [Off]**: The previous trails data are saved when the range is changed. The trails are not restarted and the saved trails are not updated. When you return the range scale to the previous range scale, the saved trails are displayed and updated.
 - [On]**: The previous trails are zoomed in or out depending on the changed scale and updated.

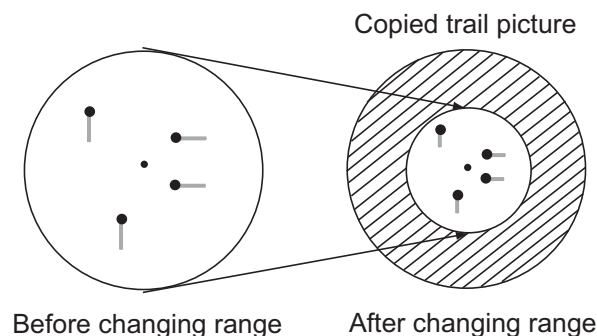

How trail copy operates

1. DESCRIPTION OF OPERATION

Note: If the newly selected range is less than or equal to 1/4 of the previous range, trails are erased. If the newly selected range is longer than the previous range, the previous trails are left to be displayed.

5. Press the **MENU** key to close the menu.

1.24.8 Narrow trails

You can display the target trails in thin trails. When there are many targets on the screen, you can separate trails close to one another with this function.

1. Press the **MENU** key to open the menu.
2. Use the Cursorpad (▲ or ▼) to select [Target Trails] and press the **ENTER** key.
3. Use the Cursorpad (▲ or ▼) to select [Narrow] and press the **ENTER** key.



Narrow options

4. Use the Cursorpad (▲ or ▼) to select [Off] or [On] then press the **ENTER** key.
5. Press the **MENU** key to close the menu.

1.24.9 Your ship trail

You can show the trail of your ship as follows:

1. Press the **MENU** key to open the menu.
2. Use the Cursorpad (▲ or ▼) to select [Target Trails] and press the **ENTER** key.
3. Use the Cursorpad (▲ or ▼) to select [Own Ship] and press the **ENTER** key.

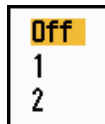

Own Ship options

4. Use the Cursorpad (▲ or ▼) to select [Off], [1] or [2] then press the **ENTER** key.
[Off]: Hide the trail of your ship.
[1]: Show the trail of your ship.
[2]: Show the trail of your ship, but hide the trail of sea clutter near your ship.
5. Press the **MENU** key to close the menu.

1.25 How to Send the Target Position and Enter the Origin Mark

The **TLL** key functions to send the cursor position to a chart plotter and put an origin mark (P) at the cursor position on the radar. Use the Cursorpad to put the cursor on a target and press the **TLL** key. You can enter up to 20 origin marks on the radar display. When the capacity for origin marks is reached, the oldest mark is erased to make room for the latest mark, to keep a maximum of 20 marks. To erase a mark, put the cursor on the mark and press the **CANCEL/HL OFF** key.

TLL key mode

You can select how to handle TLL position.

1. Press the **MENU** key to open the menu.
2. Use the Cursorpad (▲ or ▼) to select [Others] and press the **ENTER** key.
3. Use the Cursorpad (▲ or ▼) to select [TLL Key Mode] and press the **ENTER** key.



TLL Key Mode options

4. Use the Cursorpad (▲ or ▼) to select [TLL Output], [Origin Mark] or [Both] then press the **ENTER** key.
 - [TLL Output]:** Send the latitude and longitude of the cursor position to a chart plotter. (Position and heading signal are required.)
 - [Origin Mark]:** Enter an origin mark at the cursor position on the radar display. (Position and heading signal are required.)
 - [Both]:** Send the target position to a chart plotter and enter an origin mark on the radar display.
5. Press the **MENU** key to close the menu.

Note: When you turn off the power, all origin marks are deleted and not saved.

1.26 How to Hide the Heading Line Temporarily

The heading line indicates the heading of your ship in all display modes. The heading line is a line from your ship position to the outer edge of the radar display area. The heading line appears at zero degrees on the bearing scale in head-up and true view modes. The heading line changes the orientation depending on the ship orientation in north-up and true motion modes and when the course is changed in the course-up mode.

To hide the heading line (and all marks for River and Sea purpose) and display only targets, press and hold the **CANCEL/HL OFF** key. To display the heading line again, release the key.

1.27 Presentation Brilliance

You can adjust the brilliance for the following menu items from the [Brill/Color] menu.

[Echo Brill]: Brilliance for the echoes (setting range: 1 - 8)

[Rings Brill]: Brilliance for the range rings (setting range: Off, 1 - 4)

[Mark Brill]: Brilliance for the marks (EBL, VRM, etc.) (setting range: 1 - 4)

[HL Brill]: Brilliance for the heading line (setting range: 1 - 4)

[Character Brill]: Brilliance for the characters (setting range: 1 - 4)

1.28 Custom Setup

1.28.1 About custom setup

When your navigating environment or task changes, you must adjust the radar. Instead of changing radar settings case by case, you can assign the **CUSTOM** key to provide best settings for common conditions.

There are three default custom setups for the internal computer of the radar (see the table on the next page). You can adjust these settings on the [Custom 1], [Custom 2] and [Custom 3] menus to meet your navigation needs.

To activate a custom setup, press the **CUSTOM** key. The **CUSTOM** key switches between Custom 1, Custom 2 or Custom 3 each time you press the key. (Custom setup numbers which are turned off are ignored.) The selected custom setup name is shown at the upper-left corner. To escape from custom setup, operate any control.

1.28.2 Description of custom setup items

Description of custom setup items

Menu item	Available settings	See section
[Custom1(2 or 3)]	Turn on/off each custom program.	
[Copy]	Copy settings from the [Echo] menu. The message "Complete" appears after the copying is completed.	
[Gain Mode]	[Auto]: Automatic gain adjustment according to noise level [Manual]: Manual gain adjustment	1.9
[Manual Gain]	Copy the current position of the GAIN knob when you do [Copy]. This item is for read-only.	
[Sea Mode]	[Auto]: Automatic sea clutter adjustment according to sea state [Manual]: Manual sea clutter adjustment	1.10
[Auto Sea]	[Coastal]: Suppress both land and sea clutter. [Advanced]: Automatically discriminate land echoes from sea reflections to suppress only sea reflections.	1.10
[Manual Sea]	Copy the current position of the A/C SEA knob when you do [Copy]. This item is for read-only.	
[Rain Mode]	[Auto]: Automatic rain clutter adjustment according to rain cloud [Manual]: Manual rain clutter adjustment	1.11
[Auto Rain]	[Calm]: For light rain [Moderate]: When you can not reduce the rain clutter with [Calm] mode [Rough]: For heavy rain	1.11
[Manual Rain]	Copy the current position of the A/C RAIN knob when you do [Copy]. This item is for read-only.	
[A/C Auto]	[Off], [On]	1.12

Menu item	Available settings	See section
[Pulse Length]	[Short] or [Long], you can select on 1.5, 1.6, 3.0 and 3.2 nm ranges.	1.18
[Echo Stretch]	[Off], [1], [2], [3]	1.22
[Echo Average]	[Off], [1], [2], [Auto]	1.23
[Noise Rejector]	[Off], [On]	1.30
[Wiper]	[Off], [1], [2]	1.31
[Int Rejector]	[Off], [1], [2], [3]	1.14
[Display-Dynamic]	[Narrow]: Erase weak echoes. [Normal]: Normal use [Wide]: Display weaker echoes compared to [Narrow].	1.36
[Display-Curve]	[1]: Reduce weak echoes. [2]: Normal use [3]: Display weaker echoes in stronger color compared to [1].	1.37
[Color Erase]	0 - 11	1.44.3

1.28.3 How to set custom setups

1. Press the **MENU** key to open the menu.
2. Use the Cursorpad (**▲** or **▼**) to select [Custom 1 (2 or 3)] and press the **ENTER** key.

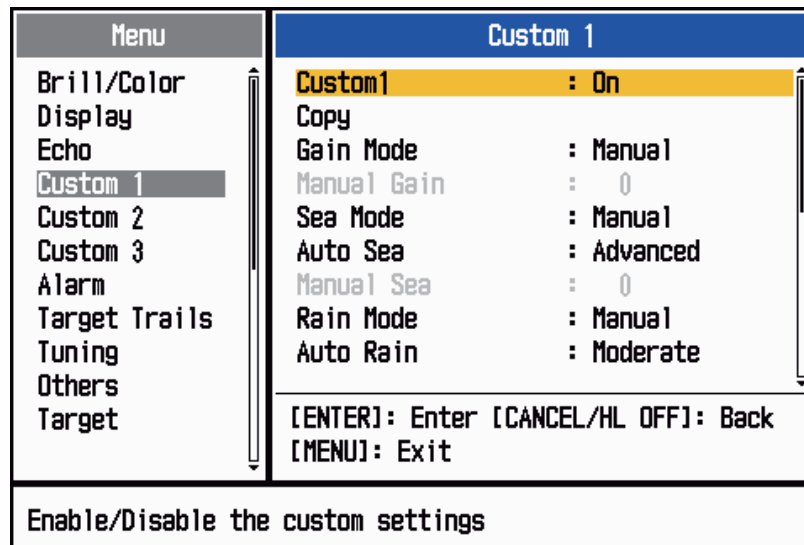

Custom menu

3. Set menu items.
Note: For easy set up, you can copy the settings of the [Echo] menu (to [Custom 1], [Custom 2], [Custom 3]). Select [Copy] and press the **ENTER** key. When the copying is completed, the message "Complete" appears. To erase this message, press any key.
4. Press the **MENU** key to close the menu.

1.29 How to Program Function Keys (F1, F2 and F3 keys)

You can program function keys (**F1**, **F2** and **F3**) to provide one-touch access to a required function.

Function key operation

To activate a function, press function key, **F1**, **F2** or **F3**. Press same key to change the setting.

The default programs are [Gain Mode] for **F1**, [Sea Mode] for **F2**, [A/C Auto] for **F3**. When you press the **F1** or **F2** key, the window for Gain/Sea/Rain indicator shows. See section 1.9 and 1.10 for operation. When you press the **F3** key, [A/C Auto] is turned on.

How to change a function key program

1. Press the **MENU** key to open the menu.
2. Use the Cursorpad (▲ or ▼) to select [Others] and press the **ENTER** key.
3. Use the Cursorpad (▲ or ▼) to select [F1 (F2 or F3) Setup] and press the **ENTER** key.
4. Use the Cursorpad (▲ or ▼) to select a function from the list and press the **ENTER** key. Below are the available functions.

Rings Brill	Pulse Length	WPT Mark
Mark Brill	Echo Stretch	EBL Reference
HL Brill	Echo Average	VRM Unit
Character Brill	Noise Rejector	Cursor Position
View Position	Wiper	TLL Key Mode
Display Color	Int Rejector	Vector Reference
Echo Color	Display-Dynamic	History Dots
Background Color	Display-Curve	History Interval
Character Color	2nd Echo Rejector	CPA
Menu Transparency	Target Alarm 1	TCPA
Echo Color Mode	Target Alarm 2	Proximity
Display Mode	Alarm Level	ARPA-Display
Zoom	Watchman	ARPA-Color
Zoom Mode	Panel Buzzer	ARPA-Auto Acquisition
Echo Area	External Buzzer	ARPA-ACK Lost Targets
Data Box	Trails-Gradation	AIS-Display
STBY Display	Trails-Color	AIS-Color
Gain Mode	Trails-Mode	AIS-Sort By
Sea Mode	Trails-Level	AIS-ACK Lost Targets
Auto Sea	Trails-Restart	GPS-Mode
Rain Mode	Trails-Narrow	GPS-Datum
Auto Rain	Trails-Own Ship	GPS-WAAS
A/C Auto	Tuning Mode	

Function list

5. Press the **MENU** key to close the menu.

1.30 Noise Rejector

White noise can appear on the screen as random "marks". You can reduce this noise as follows:

1. Press the **MENU** key to open the menu.
2. Use the Cursorpad (▲ or ▼) to select [Echo] and press the **ENTER** key.
3. Use the Cursorpad (▲ or ▼) to select [Noise Rejector] and press the **ENTER** key.



Noise Rejector options

4. Use the Cursorpad (▲ or ▼) to select [Off] or [On] then press the **ENTER** key.
5. Press the **MENU** key to close the menu.

1.31 Wiper

The wiper feature automatically reduces the brilliance of unwanted weak signals (noise, sea clutter, rain clutter, etc.) and unnecessary signals, like radar interference, to clear the picture of unnecessary echoes. The result of wiper depends on the wiper setting used and whether echo averaging is turned on or off, as described below.

Echo averaging and wiper states and wiper effect

	Wiper 1	Wiper 2
Echo Average Off	Processing content A	
Echo Average On (1, 2, Auto)	Processing content A	Processing content B

Processing content A: The brilliance of unnecessary weak echoes, like noise and radar interference, is reduced to clear the picture. The difference between wiper 1 and 2 is that brilliance is lowered more slowly in 1.

Processing content B: Echo averaging is automatically turned on from off when the wiper feature is turned on. You can see how the picture changes with the echo averaging turned off and turned on.

To activate the wiper feature, do the following:

1. Press the **MENU** key to open the menu.
2. Use the Cursorpad (▲ or ▼) to select [Echo] and press the **ENTER** key.
3. Use the Cursorpad (▲ or ▼) to select [Wiper] and press the **ENTER** key.

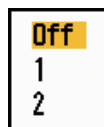

Wiper options

4. Use the Cursorpad (▲ or ▼) to select [1] or [2] then press the **ENTER** key.
5. Press the **MENU** key to close the menu.

Note: When the [Display Mode] is [True View], this function is not available (see section 1.7.2).

1.32 How to Reduce Second-trace Echoes

Echoes from very distant targets can appear as false echoes (second-trace echoes) on the screen. The second-trace echo occurs when the return echo is received one transmission cycle later, or after a next transmission of radar pulse.

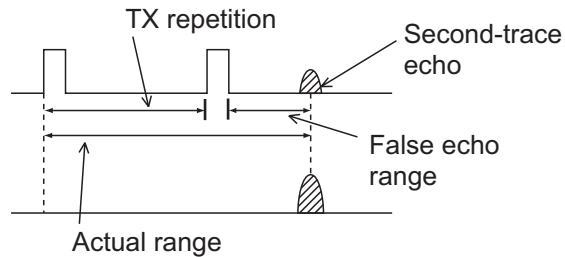

Second-trace echoes

1. Press the **MENU** key to open the menu.
2. Use the Cursorpad (▲ or ▼) to select [Echo] and press the **ENTER** key.
3. Use the Cursorpad (▲ or ▼) to select [2nd Echo Rejector] and press the **ENTER** key.



2nd Echo Rejector options

4. Use the Cursorpad (▲ or ▼) to select [Off] or [On] then press the **ENTER** key.
5. Press the **MENU** key to close the menu.

1.33 Watchman

The Watchman sounds the buzzer to tell the operator to check the radar display. The radar transmits for one minute and then goes into standby for the selected time interval. If the target alarm is active and a target is found in the alarm zone, Watchman is cancelled, and the radar transmits continuously.

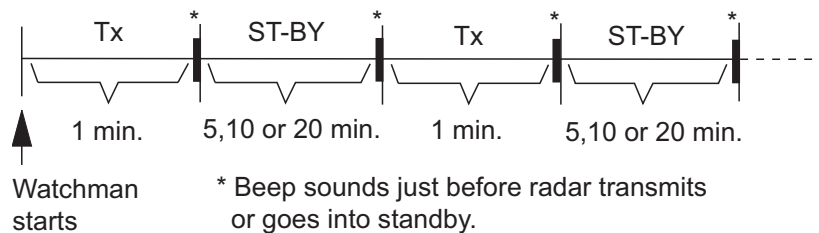

How watchman operates

In standby, the timer near the <WATCH> label at the center of the screen counts down the remaining time until the transmission. When the set time interval has passed, the audio alarm sounds, the timer disappears and the radar transmits for one minute. After one minute, the audio alarm sounds and the watch alarm timer again begins the count-down sequence.

If you press the **STBY/TX** key before the set time interval comes, the radar goes into transmission.

Do the following to activate the Watchman:

1. Press the **MENU** key to open the menu.
2. Use the Cursorpad (▲ or ▼) to select [Alarm] and press the **ENTER** key.
3. Use the Cursorpad (▲ or ▼) to select [Watchman] and press the **ENTER** key.



Watchman options

4. Use the Cursorpad (▲ or ▼) to select [Off] or the time ([5min], [10min] or [20min]) then press the **ENTER** key.
5. Press the **MENU** key to close the menu.

1.34 Color Selections

1.34.1 Preset colors

This radar is preset with color combinations that provide best viewing in daytime, nighttime and twilight. Below are the default color settings for each display item and display color setting.

Display item, color design and color

Display item	Day	Night	Twilight	Custom
Characters	Black	Red	Green	Green
Range rings, marks	Green	Red	Green	Green
Echo	Yellow	Green	Green	Yellow
Background	White	Black	Blue	Black

1. Press the **MENU** key to open the menu.
2. Use the Cursorpad (▲ or ▼) to select [Brill/Color] and press the **ENTER** key.
3. Use the Cursorpad (▲ or ▼) to select [Display Color] and press the **ENTER** key.



Display Color options

4. Use the Cursorpad (▲ or ▼) to select the color design and press the **ENTER** key.
5. Press the **MENU** key to close the menu.

1.34.2 Custom colors

The custom color design lets you select preferred echo, background, characters, range rings and marks colors. Select [Custom] in the [Display Color] menu item (see section 1.34.1) to use the user selected echo, background, characters, range rings and marks colors.

1. Press the **MENU** key to open the menu.
2. Use the Cursorpad (▲ or ▼) to select [Brill/Color] and press the **ENTER** key.
3. Use the Cursorpad (▲ or ▼) to select [Echo Color] and press the **ENTER** key.

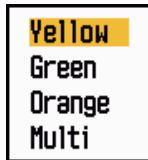

Echo Color options

4. Use the Cursorpad (▲ or ▼) to select an echo color and press the **ENTER** key. [Multi] displays echoes in colors of red, yellow and green according to echo strength, and [Multi] is not available in the [IEC] or [Russian-River] mode.
5. Use the Cursorpad (▲ or ▼) to select [Background Color] and press the **ENTER** key.

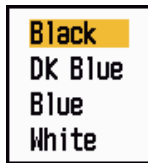

Background Color options

6. Use the Cursorpad (▲ or ▼) to select a background color and press the **ENTER** key.
7. Use the Cursorpad (▲ or ▼) to select [Character Color] and press the **ENTER** key.



Character Color options

8. Use the Cursorpad (▲ or ▼) to select a character color (including range rings and marks) and press the **ENTER** key.
9. Press the **MENU** key to close the menu.

1.35 Navigation Data

1.35.1 Navigation data during standby

The navigation data is shown in standby when [STBY Display] on the [Display] menu is set to [Nav]. Appropriate sensors are required to display the data.

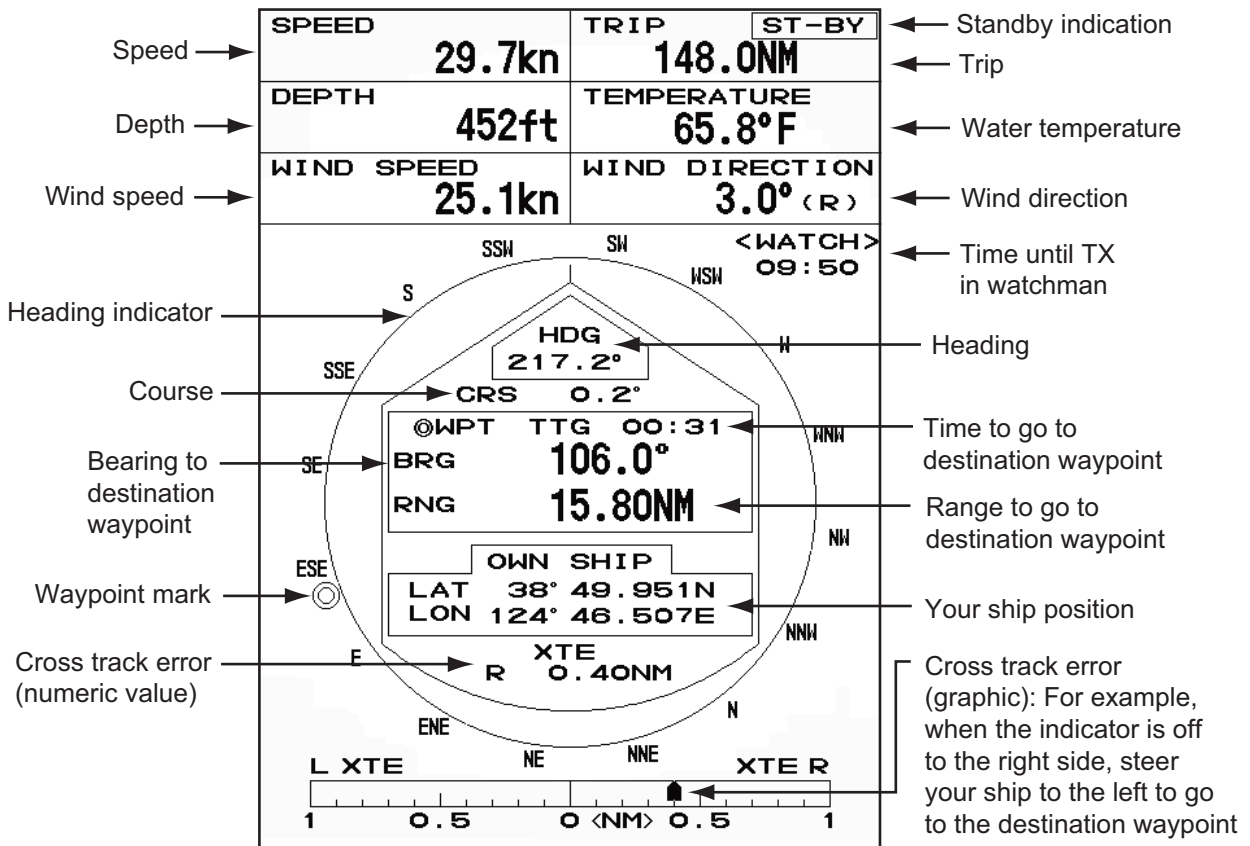

Navigation data display at standby

1.35.2 Navigation data at the bottom of the screen

The navigation data is displayed at the bottom of the screen.

- Cursor latitude position
- Cursor longitude position
- Time to go to cursor position

OWN SHIP		+ CURSOR		WAYPOINT	
LAT	34°56.123N	LAT	34°56.123N	BRG	14.8°
LON	135°34.567E	LON	135°34.567E	RNG	0.876NM
SPEED	12.3KN	TTG	01:00	TTG	00:20

Your ship position and speed

- Bearing from your ship to waypoint
- Range from your ship to waypoint
- Time to go from your ship position to waypoint

Navigation data

1. DESCRIPTION OF OPERATION

To show or hide the navigation data at the bottom of the screen, do the following:

1. Press the **MENU** key to open the menu.
2. Use the Cursorpad (▲ or ▼) to select [Display] and press the **ENTER** key.
3. Use the Cursorpad (▲ or ▼) to select [Data Box] and press the **ENTER** key.

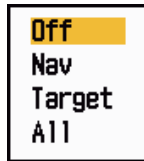

Data Box options

4. Use the Cursorpad (▲ or ▼) to select an option and press the **ENTER** key.
[Off]: Turn off the data display.
[Nav]: Navigation data
[Target]: ARPA and AIS target data (See section 3.8 and 4.5.)
[All]: Navigation data plus ARPA and AIS target data
5. Press the **MENU** key to close the menu.

1.36 Dynamic Range

You can change the dynamic range to erase unwanted weak echoes (sea reflections, etc.). Select [Narrow], [Normal] or [Wide] depending on conditions.

1. Press the **MENU** key to open the menu.
2. Use the Cursorpad (▲ or ▼) to select [Echo] and press the **ENTER** key.
3. Use the Cursorpad (▲ or ▼) to select [Display-Dynamic] and press the **ENTER** key.

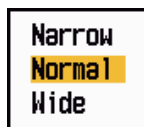

Display-Dynamic options

4. Use the Cursorpad (▲ or ▼) to select [Narrow], [Normal] or [Wide] then press the **ENTER** key.
[Narrow]: Erase weak echoes.
[Normal]: Normal use
[Wide]: Display weaker echoes compared to [Narrow].
5. Press the **MENU** key to close the menu.

1.37 Characteristics Curve

You can change the characteristics curve to reduce unwanted weak echoes (sea reflections, etc.). Select [1], [2] or [3] depending on conditions when unwanted weak echoes hide wanted targets.

1. Press the **MENU** key to open the menu.
2. Use the Cursorpad (▲ or ▼) to select [Echo] and press the **ENTER** key.
3. Use the Cursorpad (▲ or ▼) to select [Display-Curve] and press the **ENTER** key.



Display-Curve options

4. Use the Cursorpad (▲ or ▼) to select [1], [2] or [3] then press the **ENTER** key.
 - [1]**: Reduce weak echoes.
 - [2]**: Normal use
 - [3]**: Display weaker echoes in stronger color compared to [1].

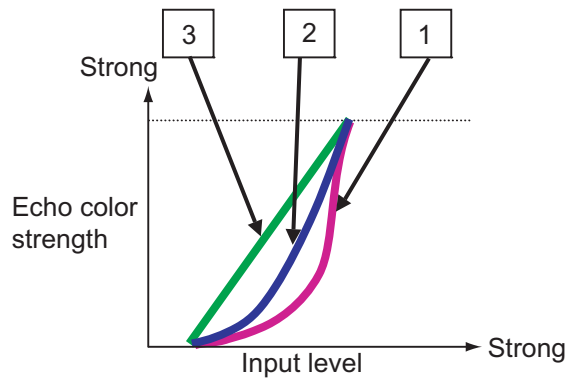

Display curve

5. Press the **MENU** key to close the menu.

1.38 Waypoint Marker

The waypoint marker shows the location of the destination waypoint set on a navigation plotter. The heading signal or course data are required. You can turn on/off the waypoint marker as follows:

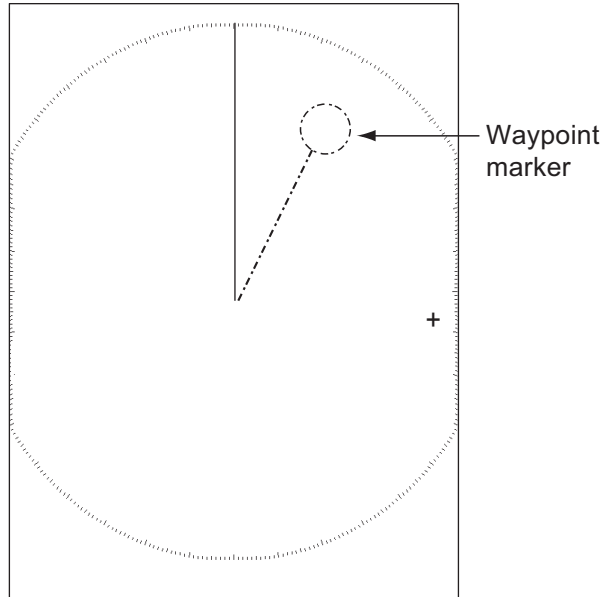

Waypoint marker

1. Press the **MENU** key to open the menu.
2. Use the Cursorpad (▲ or ▼) to select [Others] and press the **ENTER** key.
3. Use the Cursorpad (▲ or ▼) to select [WPT Mark] and press the **ENTER** key.



WPT Mark options

4. Use the Cursorpad (▲ or ▼) to select [Off] or [On] then press the **ENTER** key.
5. Press the **MENU** key to close the menu.

1.39 Alarm Message

The alarm status window shows all currently violated alarms.

Note: The alarm status window is not automatically displayed when an alarm occurs.

1. Press the **MENU** key to open the menu.
2. Use the Cursorpad (▲ or ▼) to select [Alarm] and press the **ENTER** key.

3. Use the Cursorpad (▲ or ▼) to select [Alarm Status] and press the **ENTER** key.

Alarm Status	
[SIGNAL MISSING]	TRIGGER HEADING BEARING GYRO VIDEO POSITION NMEA_HDG
[TARGET ALARM1]	IN OUT
[TARGET ALARM2]	IN OUT
[ARPA ALARM]	COLLISION LOST PROXIMITY
[AIS ALARM]	COLLISION PROXIMITY
[AIS SYSTEM]	TX ANT CH1 CH2 CH70 FAIL MKD EPFS L/L SOG COG HDG ROT
[OTHER]	OVER_TEMP
[CANCEL/HL OFF]:Close	

Alarm Status display

4. Press the **CANCEL/HL OFF** key to close the alarm status display.
 5. Press the **MENU** key to close the menu.

Alarm category	Meaning
SIGNAL MISSING*	
TRIGGER	Trigger signal lost (only for remote display)
HEADING	Heading signal lost
BEARING	Bearing signal lost
GYRO	AD-10 format gyro signal lost
VIDEO	Video signal lost
POSITION	NMEA format position data lost
NMEA_HDG	NMEA format heading signal lost
TARGET ALARM1(2)	
IN	An echo has entered a target alarm zone.
OUT	An echo has exited a target alarm zone.
ARPA ALARM	
COLLISION	CPA and TCPA of an ARPA target is less than CPA and TCPA alarm settings.
LOST	Acquired ARPA target becomes lost.
PROXIMITY	The range to an ARPA target is less than the user-set proximity alarm range.
AIS ALARM	
COLLISION	CPA and TCPA of an AIS target is less than CPA and TCPA alarm settings.
PROXIMITY	The range to an AIS target is less than the user-set proximity alarm range.

1. DESCRIPTION OF OPERATION

Alarm category	Meaning
AIS SYSTEM*	
TX	TX stopped or TX error
ANT	Antenna VSWR problem
CH1	TDM2 RX1 board problem
CH2	TDM2 RX2 board problem
CH70	RX channel 70 problem
FAIL	System failure
MKD	Minimum input device lost
EPFS	Navigator (GPS, etc.) problem
L/L	Position data lost
SOG	Speed data lost
COG	Course data lost
HDG	Heading data lost
ROT	Rate of turn data lost
OTHER*	
OVER_TEMP	The temperature of the equipment is more than the specified value.

*: Have a qualified technician check the equipment.

1.40 Echo Area

You can select the display area from [Normal] or [Full Screen].

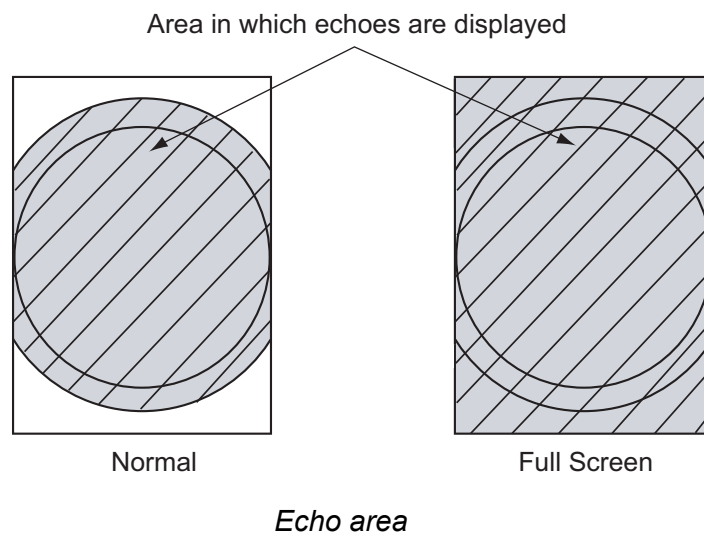

1. Press the **MENU** key to open the menu.
2. Use the Cursorpad (▲ or ▼) to select [Display] and press the **ENTER** key.

- Use the Cursorpad (▲ or ▼) to select [Echo Area] and press the **ENTER** key.

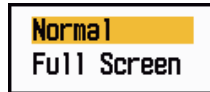

Echo Area options

- Use the Cursorpad (▲ or ▼) to select [Normal] or [Full Screen] then press the **ENTER** key.
- Press the **MENU** key to close the menu.

1.41 Initial Sub Menu

The [Initial] sub menu in the [System] menu contains the items which allow you to customize your radar to meet your needs.

1.41.1 How to open the Initial sub menu

- Press the **MENU** key to open the menu.
- Use the Cursorpad (▲ or ▼) to select [Initial] and press the **ENTER** key.

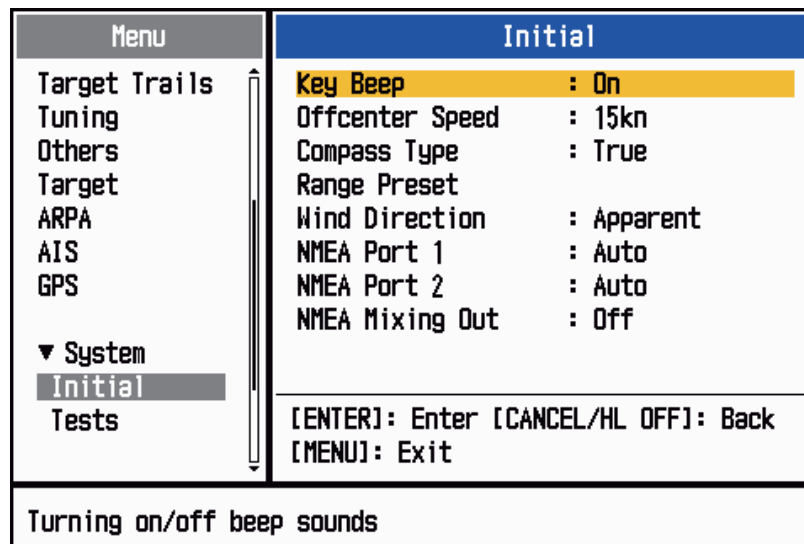

Initial sub menu

1.41.2 Description of Initial sub menu

[Key Beep]: When a key is pressed, a beep sounds. You can turn on or off this beep.

[Offcenter Speed]: Set the speed of your ship to calculate amount of your ship's off-center. The setting range is 1-99 (kn).

[Compass Type]: Select the type of bearing sensor connected to the radar; [True] (gyrocompass, satellite compass) or [Magnetic] (magnetic compass).

[Range Preset]: You can select the radar ranges. Select a range and press the **ENTER** key to switch on and off. At least two ranges must be turned on. The maximum range available depends on the radar model. 0.0625 is not available in KM (kilometers).

1. DESCRIPTION OF OPERATION

0.0625	On
0.125	On
0.25	On
0.5	On
0.75	On
1	Off
1.5	On
1.6	Off
2	Off
3	On
3.2	Off
4	Off
6	On
8	Off
12	On
16	Off
24	On
32	Off
36	On
48	Off
64	Off
Exit?	Yes

0.0625	Off
0.125	On
0.25	On
0.5	On
0.75	On
1	Off
1.5	On
1.6	Off
2	Off
3	On
3.2	Off
4	Off
6	On
8	Off
12	On
16	Off
24	On
32	Off
36	On
48	Off
64	Off
Exit?	Yes

0.0625	On
0.125	On
0.25	On
0.5	On
0.75	On
1	Off
1.5	On
1.6	Off
2	Off
3	On
3.2	Off
4	Off
6	On
8	Off
12	On
16	Off
24	On
32	Off
36	On
48	Off
64	Off
Exit?	Yes

NM (nautical miles)

KM (kilometers)

SM (statute miles)

Available ranges for MODEL 1835

0.0625	On
0.125	On
0.25	On
0.5	On
0.75	On
1	Off
1.5	On
1.6	Off
2	Off
3	On
3.2	Off
4	Off
6	On
8	Off
12	On
16	Off
24	On
32	Off
36	Off
48	On
64	Off
Exit?	Yes

0.0625	Off
0.125	On
0.25	On
0.5	On
0.75	On
1	Off
1.5	On
1.6	Off
2	Off
3	On
3.2	Off
4	Off
6	On
8	Off
12	On
16	Off
24	On
32	Off
36	Off
48	On
64	Off
Exit?	Yes

0.0625	On
0.125	On
0.25	On
0.5	On
0.75	On
1	Off
1.5	On
1.6	Off
2	Off
3	On
3.2	Off
4	Off
6	On
8	Off
12	On
16	Off
24	On
32	Off
36	Off
48	On
64	Off
Exit?	Yes

NM (nautical miles)

KM (kilometers)

SM (statute miles)

Available ranges for MODEL 1935

0.0625	On
0.125	On
0.25	On
0.5	On
0.75	On
1	Off
1.5	On
1.6	Off
2	Off
3	On
3.2	Off
4	Off
6	On
8	Off
12	On
16	Off
24	On
32	Off
36	Off
48	On
64	On
Exit?	Yes

0.0625	Off
0.125	On
0.25	On
0.5	On
0.75	On
1	Off
1.5	On
1.6	Off
2	Off
3	On
3.2	Off
4	Off
6	On
8	Off
12	On
16	Off
24	On
32	Off
36	Off
48	On
64	On
Exit?	Yes

0.0625	On
0.125	On
0.25	On
0.5	On
0.75	On
1	Off
1.5	On
1.6	Off
2	Off
3	On
3.2	Off
4	Off
6	On
8	Off
12	On
16	Off
24	On
32	Off
36	Off
48	On
64	On
Exit?	Yes

NM (nautical miles)

KM (kilometers)

SM (statute miles)

Available ranges for MODEL 1945

[Wind Direction]: Wind direction is shown as [Apparent] or [True].

[NMEA Port 1]: Set the baud rate of the equipment connected to Port 1 ([Auto], [4800], or [38400] (bps)). [Auto] provides automatic detection of baud rate from 4800, 9600, 19200 or 38400 (bps).

[NMEA Port 2]: Same function as Port 1 but for Port 2.

[NMEA Mixing Out]: Data input to Port 1 may be output from Port 2 mixed with data output to Port 2. Select [On] to use this feature.

1.42 Units Sub Menu

You can select the unit of measurement for range, ship speed, depth, temperature and wind speed on the [Units] sub menu in the [System] menu. You can not open this sub menu in normal operation. To open this menu, select [Units], hold the **CANCEL/HL OFF** key and press the **MENU** key five times.

Menu	Units
Target	Range Unit : NM
ARPA	Ship Speed Unit : kn
AIS	Depth Unit : ft
GPS	Temperature Unit : °F
▼ System	Wind Speed Unit : kn
Initial	
Tests	
Sector Blanks	
Units	
Installation	[ENTER]: Enter [CANCEL/HL OFF]: Back [MENU]: Exit
Choosing an unit of range	

Units sub menu

[Range Unit]: NM, KM, SM

[Ship Speed Unit]: kn, km/h, mph

[Depth Unit]: m, ft, fa, pb, HR

[Temperature Unit]: °C, °F

[Wind Speed Unit]: kn, km/h, mph, m/s

1.43 Sector Blank

You must prevent the transmission in some areas to protect passengers and crew from microwave radiation. Also, if the reflections of echoes from the mast appear on the screen, you must prevent the transmission in that area. You can set two sectors.

1. Press the **MENU** key to open the menu.
2. Use the Cursorpad (▲ or ▼) to select [Sector Blanks] and press the **ENTER** key.
3. Use the Cursorpad (▲ or ▼) to select [Sect-Blank 1 (or 2) Status] and press the **ENTER** key.



Sect-Blank Status options

4. Use the Cursorpad (▲ or ▼) to select [On] and press the **ENTER** key.
5. Use the Cursorpad (▲ or ▼) to select [Sect-Blank 1 (or 2) Start] and press the **ENTER** key.

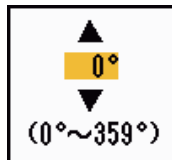

Sect-Blank Start setting window

6. Use the Cursorpad (▲ or ▼) to set the start point of the sector and press the **ENTER** key.
7. Use the Cursorpad (▲ or ▼) to select [Sect-Blank 1 (or 2) End] and press the **ENTER** key.

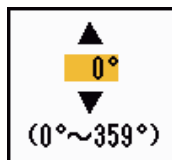

Sect-Blank End setting window

8. Use the Cursorpad (▲ or ▼) to set the end point of the sector and press the **ENTER** key.

Note 1: You can not set the sector more than 180 degrees.

Note 2: You can not set the total width of sector 1 and sector 2 more than 270 degrees.

9. Press the **MENU** key to close the menu.

As shown in the following illustration, dashed lines mark the start and end points of the sector.

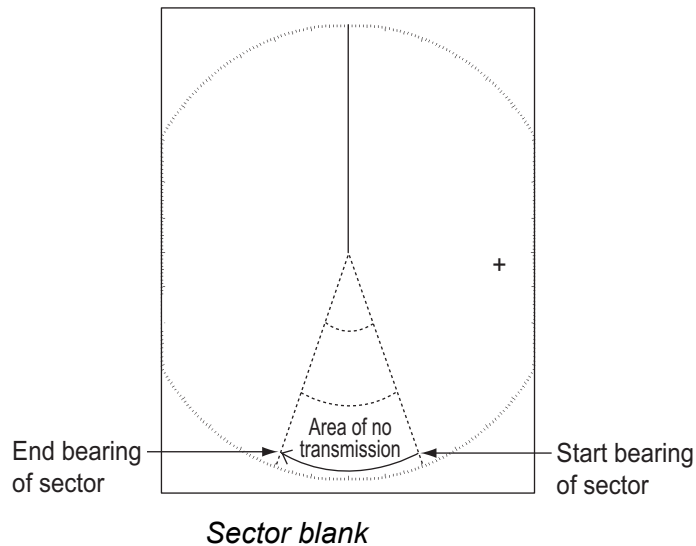

1.44 Other Menu Items

This section describes the menu items not previously described.

1.44.1 Menu items on the [Brill/Color] menu

[View Position]: You can select the angle from where you see the screen.

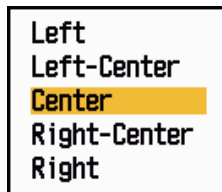

View Position options

[Menu Transparency]: You can select the degree of transparency of the menu window so the menu window does not hide the echo display. [4] is the greatest degree of transparency. [Off] functions to hide the echo display behind the menu window completely.

Note: Alpha blending technology is used for transparency effects.

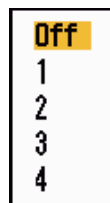

Menu Transparency options

[Echo Color Mode]: You can select the color palette from [System] or [Custom]. [System] is the pre-set color palette and [Custom] is the color palette you can set yourself. This function is not available in the [IEC] or [Russian-River] mode.

1. DESCRIPTION OF OPERATION



Echo Color Mode options

[Custom Echo Color]: You can customize the echo color with the following two methods. This function is not available in the [IEC] or [Russian-River] mode.

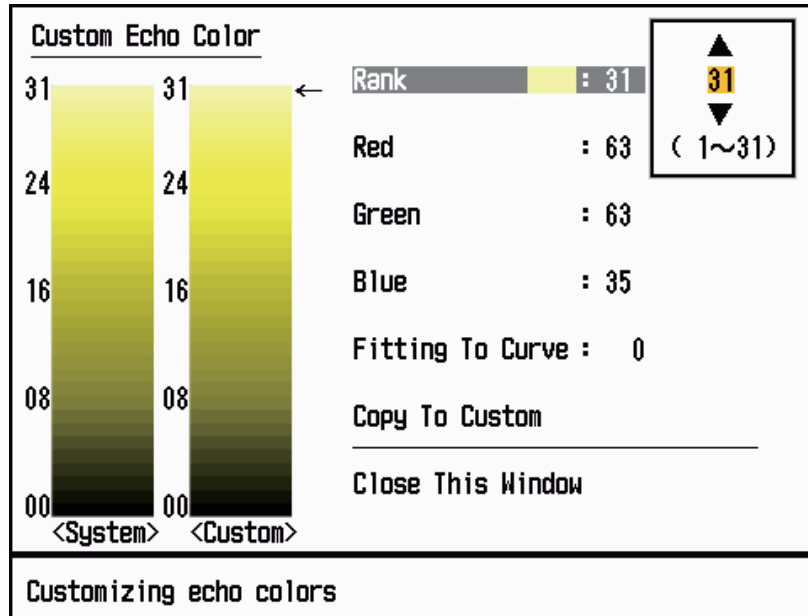

Custom Echo Color setting window

Method 1: 1) Select the echo rank to change on the [Rank] (setting range: 1 - 31).

2) Set the RGB values for selected echo rank on the [Red], [Green] and [Blue] (setting range: 0 - 63).

Method 2: 1) Select 31 on the [Rank].

2) Set the RGB values for 31 echo rank on the [Red], [Green] and [Blue] (setting range: 0 - 63).

3) Interpolate the RGB values between the maximum rank and minimum rank on the [Fitting To Curve] with the following curves (setting range: -20 to 20).

Setting range > 0: Logarithmic curve, useful to emphasize the weak echoes.

Setting range = 0: Straight line

Setting range < 0: Exponential curve, useful to emphasize the strong echoes.

[Copy To Custom]: Copy the color palette from [System] to [Custom].

1.44.2 Menu items on the [Display] menu

[Base Text Display]: You can select on/off for the text indications of the following items on the display. The settings on this function are used when you set [Echo Area] to [Full Screen] on the [Display] menu. This function is not available in the [IEC] or [Russian-River] mode.

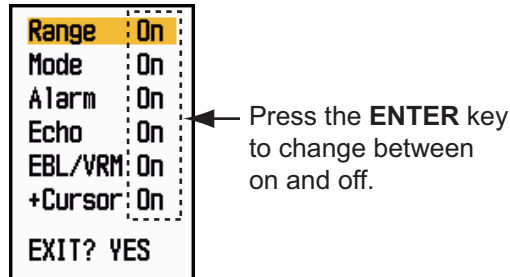

Base Text Display options

The text indications set to off appear when you operate any key. The indications disappear when there is no key operation for 10 seconds.

[Gain/Sea/Rain Bar]: Open the Gain/Sea/Rain indicator. You can check the current settings.

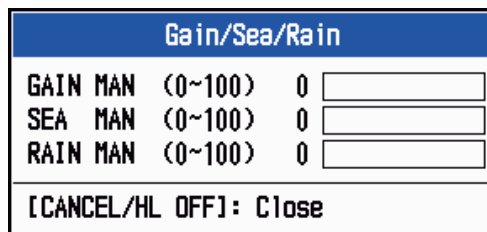

Gain/Sea/Rain Bar

[STBY Display]: Set the function of the standby display.



STBY Display options

[Normal]: Display "ST-BY" at the screen center.

[Nav]: Display navigation data.

[Economy]: Turn off the backlight of the LCD. The radar must be switched from TX to ST-BY to activate this mode.

1.44.3 Menu items on the [Echo] menu

[Color Erase]: Erase the lower echo color whose level is set here. Set a large value to display only the stronger echoes.

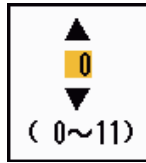

Color Erase setting window

1.45 Remote Display

You can use this radar as a remote display when you set [Input Source] to [Slave] on the [Installation] sub menu. When this setting is done, the menu and display change as described below. To display the radar image on the remote display, transmit from the main radar.

Note: The message "Please turn to STBY-mode when you change this setting." appears when you switch the mode in transmission.

Unavailable menu items

The menu items are not available with the remote display as shown in the table.

Menu	Unavailable menu item(s)
[Echo]	[Pulse Length], [2nd Echo Rejector]
[Custom 1, 2, 3]	[Pulse Length]
[Alarm]	[Watchman]
[Tuning]	All menu items are inoperative.
[System] - [Sector Blanks]	All menu items are inoperative.
[System] - [Installation]	[Antenna Rotation], [MBS Adjust],[Auto Install Setup], [Total TX Time]

Display appearance

The display changes as shown in the following illustration.

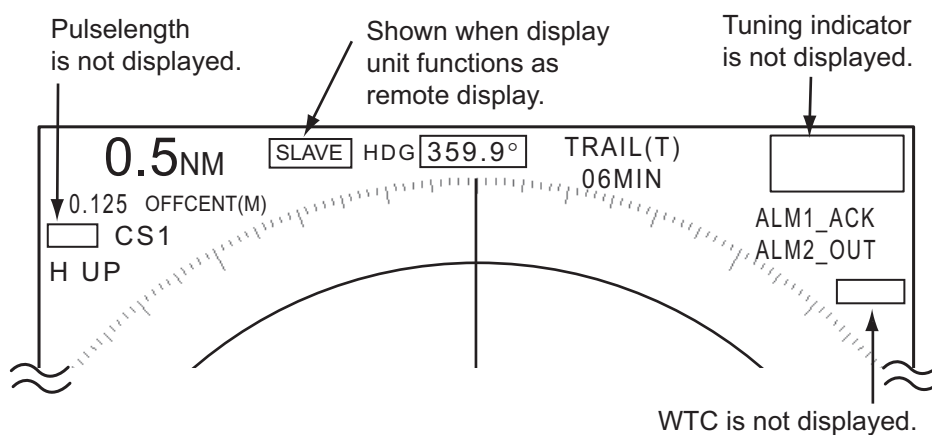

Transmitting or standby display indications for remote display

Items unavailable with Function key F1, F2 and F3

- [Pulse Length] ([Echo] menu)
- [2nd Echo Rejector] ([Echo] menu)
- [Watchman] ([Alarm] menu)
- [Tuning Mode] ([Tuning] menu)

Total TX time indication

The total TX time (TX TIME XXXXXX.XH) does not appear on the diagnostic test or on the Normal standby display.

1. DESCRIPTION OF OPERATION

This page is intentionally left blank.

2. DESCRIPTION OF RADAR

2.1 General

2.1.1 Minimum and maximum ranges

Minimum range

The minimum range is defined by the shortest distance at which, using a scale of 0.0625 or 0.125 nm, a target having an echoing area of 10 m² is shown separate from the point representing the antenna position.

The minimum range depends on the pulselength, antenna height, and signal processing (like main bang suppression and digital quantization). Use a shorter range scale as far as it gives favorable definition or clarity of picture. This MODEL 1835 series meets the requirements of IEC 62252 5.14.1 (Class A).

Maximum range

The maximum detection range, R_{max} , varies depending on the height of the antenna, the height of the target above the sea, the size, shape and material of the target, and the atmospheric conditions.

Under normal atmospheric conditions, the maximum range is equal or a little shorter than the optical horizon. The radar horizon is longer than the optical one by approximately 6% because of the diffraction property of the radar signal. The R_{max} is shown in the following formula.

$$R_{max} = 2.2 \times (\sqrt{h_1} + \sqrt{h_2})$$

where R_{max} : radar horizon (nautical miles)

h_1 : antenna height (m)

h_2 : target height (m)

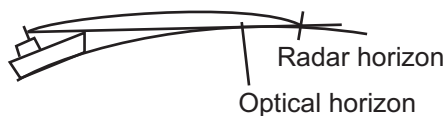

If the height of the antenna is 9 m and the height of the target is 16 m, the maximum radar range is;

$$R_{max} = 2.2 \times (\sqrt{9} + \sqrt{16}) = 2.2 \times (3 + 4) = 15.4 \text{ nm}$$

Note: The detection range is reduced by precipitation (which absorbs the radar signal).

2.1.2 Radar resolution

The bearing resolution and range resolution are important in radar resolution.

Bearing resolution

The bearing resolution is the ability of the radar to display the echoes received from two targets at the same range as the separate echoes. The bearing resolution is proportional to the antenna length and the wavelength.

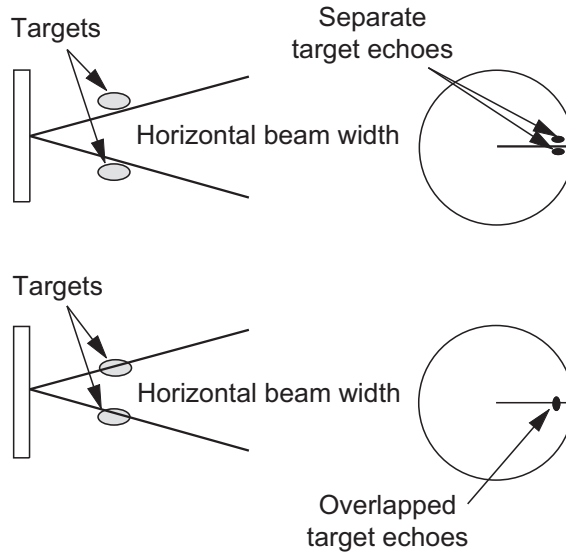

Range resolution

The range resolution is the ability to display the echoes received from two targets on the same bearing as separate echoes. The range resolution is determined by only pulselength.

The test targets used to determine the range and bearing resolution are radar reflectors that have an echoing area of 10 m².

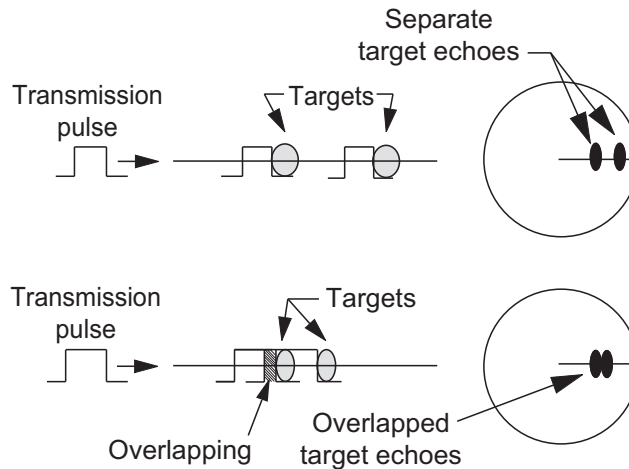

2.1.3 Bearing accuracy

One of the most important features of the radar is how accurately the bearing of a target can be measured. The accuracy of bearing measurement depends on the narrowness of the radar beam. The bearing is taken relative to the heading of the ship. Correct adjustment of the heading line at installation is important to get accurate bearings. To minimize the error when you measure the bearing of a target, put the target echo at the extreme position on the screen by selecting a suitable range.

2.1.4 Range measurement

Measurement of the range to a target is important function of the radar. There are three methods of measuring range: the fixed range rings, the Variable Range Marker (VRM), and the cursor (if set to measure range and bearing). The fixed range rings appear on the screen with a given interval and provide a rough estimate of the range to a target. The diameter of VRM is increased or decreased so that the marker touches the inner edge of the target (see section 1.15.2). The VRM is a more accurate range measurement than the fixed range rings. For cursor, see section 1.13.

2.2 False Echoes

The echo signals can appear on the screen at positions where there is no target or disappear when there are targets. These false echoes are shown below.

2.2.1 Multiple echoes

Multiple echoes occur when a transmitted pulse returns from a solid object like a large ship, bridge, or breakwater. A second, a third or more echoes can be seen on the display at double, triple or other multiples of the actual range of the target as shown below. You can reduce and remove the multiple reflection echoes with the **A/C SEA** control.

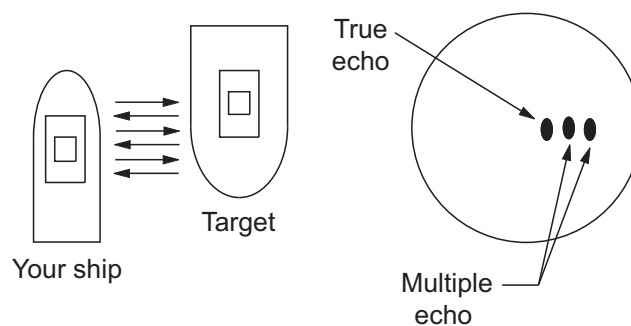

Multiple echoes

2.2.2 Sidelobe echoes

When the radar pulse is transmitted, some radiation escapes on each side of the beam, called "sidelobes". If a target is where a target can be detected by the sidelobes as well as the mainlobe, the side echoes can be shown on both sides of the true echo at the same range. Sidelobes show normally only on short ranges and from strong targets. You can reduce the sidelobes with the **A/C SEA** control.

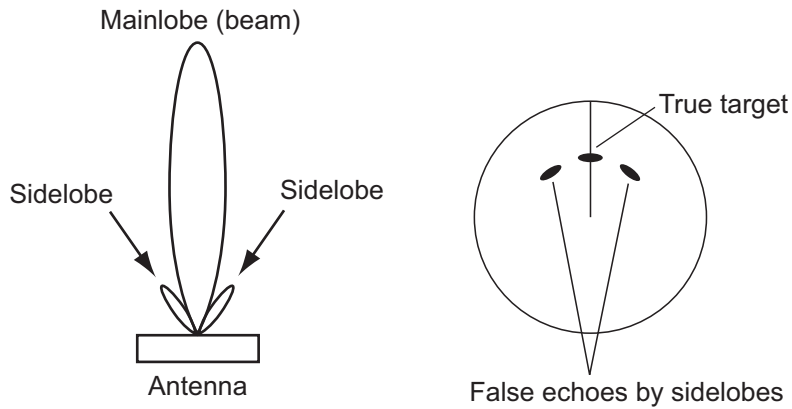

Sidelobe echoes

2.2.3 Virtual image

A large target close your ship can appear at two positions on the screen. One of them is the true echo reflected by the target. The other is a false echo which is caused by the mirror effect of a large object on or close your ship as shown in the following figure. If your ship comes close to a large metal bridge, for example, a false echo can temporarily appear on the screen.

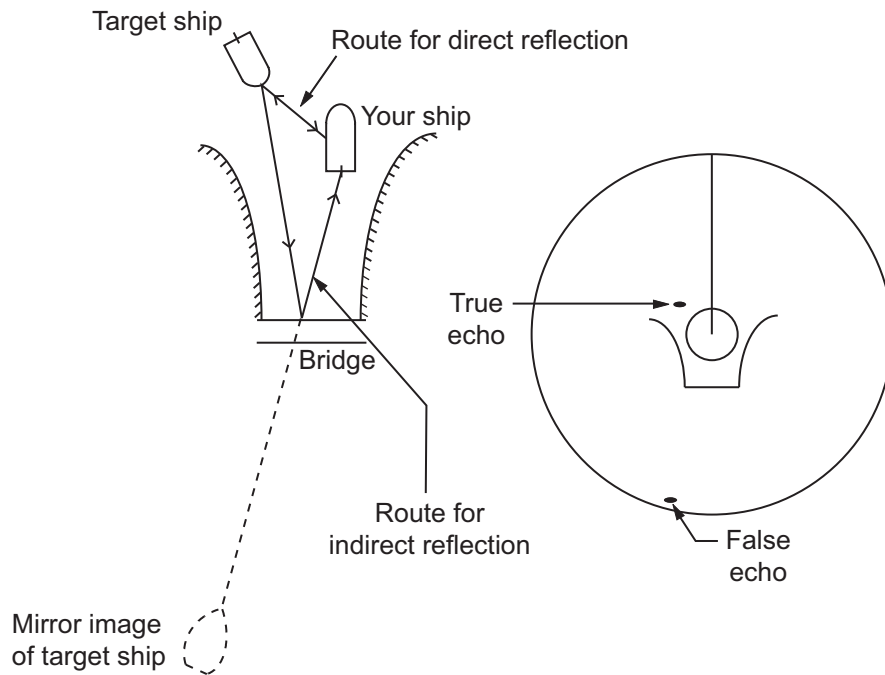

Virtual image

2.2.4 Shadow sector

Funnels, stacks, masts, or derricks near the antenna interrupt the radar beam, and a non-detecting sector can occur. Targets can not be detected within this sector.

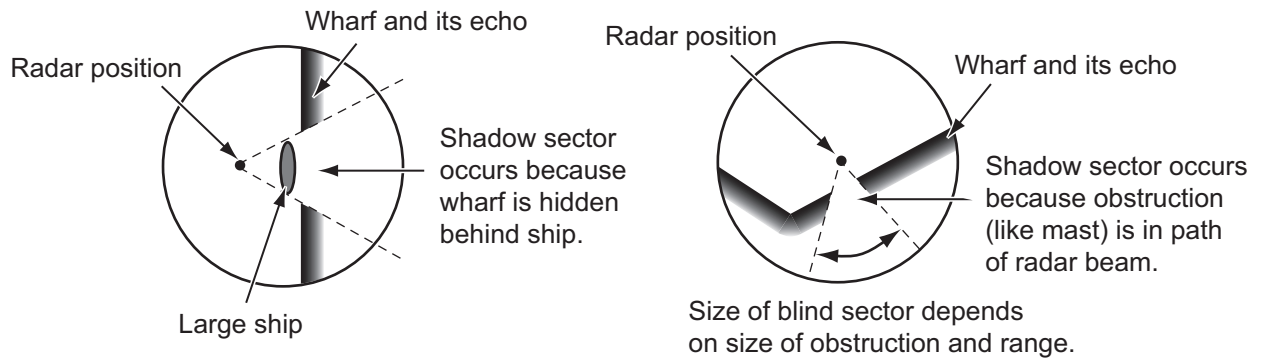

Shadow sector

2.3 SART (Search and Rescue Transponder)

2.3.1 SART description

When any X-band radar reaches within a range of approximately 8 nm, a Search and Rescue Transponder (SART) sends a response to the radar signal. The transmitter signal of response is 12-sweeps signal between 9,500 MHz to 9,200 MHz. The time of slow sweep signal is $7.5 \mu\text{s}$ and the time of fast sweep signal is $0.4 \mu\text{s}$. When the radar receives this SART signal, a line of 12 dots appears. When the position of SART is distant, the radar display shows only slow sweep signals like the illustration of screen A.

When the radar reaches the SART within approximately 1 nm, the radar display can also show the 12 responses of fast sweep signals like the illustration of screen B. The position of the SART is the closest position of the radar echoes.

Screen A: When SART is distant

Screen B: When SART is close

Lines of 12 dots are displayed in concentric arcs.

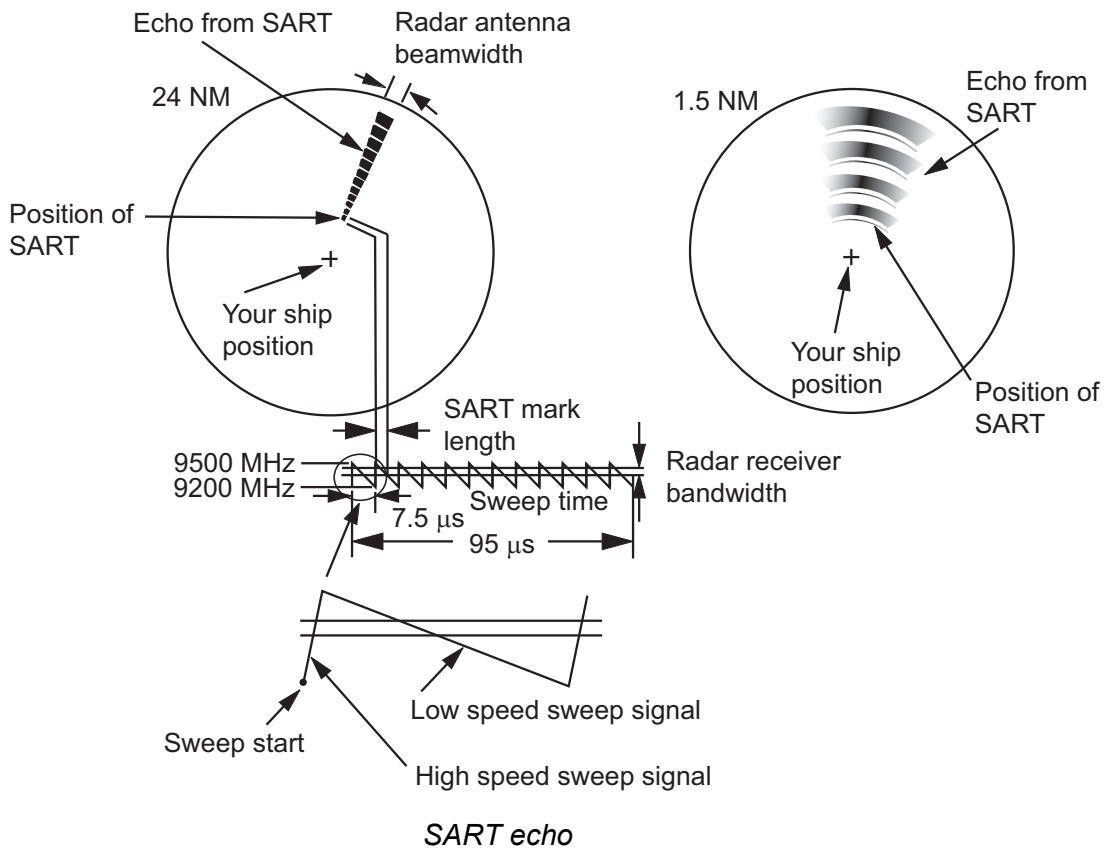

2.3.2 General remarks on receiving SART

SART range errors

When the SART is at a range greater than approximately 1 nm, the first dot is displayed at 0.64 nm beyond the true position of the SART. When the range closes so that the fast sweep responses are seen also, the first range echoes are displayed at 150 m beyond the true position.

Range scale

When you find the SART position, do as follows:

1. Use the **RANGE** key to set the range scale to 6 nm or 12 nm.
2. Turn off [A/C Auto].
3. Turn off [Int Rejector].

SART display

To display only the SART echo clearly on the radar screen, reduce the tuning on manual mode. The normal radar echoes get weak, however, the SART echoes remain. Your ship comes close to the SART, the arc for the SART display becomes larger. Most of the radar screen becomes fuzzy. Adjust the **A/C SEA** and **GAIN** controls to display the necessary screen.

2.4 RACON

A RACON is a radar beacon which emits radar-receivable signals in the radar frequency spectrum (X- or S-band). There are several signal formats; in general, the RACON signal appears on the radar screen as a rectangular echo originating at a point just beyond the position of the radar beacon. It has a Morse coded pattern. Note that the position on the radar display is not accurate.



Echoes on the radar screen

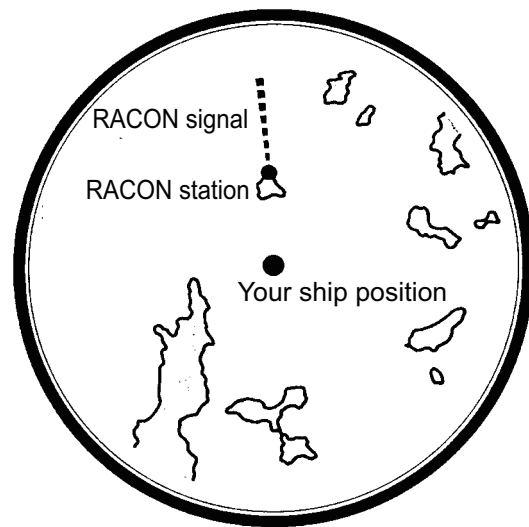

Echo description

RACON

3. ARPA OPERATION

The Automatic Radar Plotter ARP-11 (option) manually or automatically acquires and tracks ten targets. Once a target is acquired automatically or manually, a target is automatically tracked within 0.1 to 16 nm.

3.1 Precautions for Use

 CAUTION
<p>Do not depend on one navigation device for the navigation of the ship. The navigator must check all aids available to confirm position. Electronic aids are not a replacement for basic navigation principles and common sense.</p> <ul style="list-style-type: none">· The ARPA automatically tracks an automatically or manually acquired radar target and calculates its course and speed, indicating them by a vector. Since the data from the auto plotter depend on the selected radar targets, the radar must be optimally tuned for use with the auto plotter, to ensure required targets will not be lost or unnecessary targets like sea returns and noise will not be acquired and tracked.· A target is not always a landmass, reef, ship, but can be returns from the sea surface and clutter. As the level of clutter changes with the environment, the operator must correctly adjust the A/C SEA, A/C RAIN and GAIN controls so that the target echoes do not disappear from the radar screen.

 CAUTION
<p>The plotting accuracy and response of this ARPA meets IMO standards. The tracking accuracy is affected by the following:</p> <ul style="list-style-type: none">· The tracking accuracy is affected by course change. One to two minutes is required to restore vectors to full accuracy after a sudden course change. (The actual amount depends on gyrocompass specifications.)· The amount of tracking delay is inversely proportional to the relative speed of the target. Delay is on the order of 15-30 seconds for high relative speed; 30-60 seconds for low relative speed.
<p>The display accuracy is affected by the following:</p> <ul style="list-style-type: none">· Echo intensity· Pulse width of radar transmission· Radar bearing error· Gyrocompass error· Course change (your ship or target)

3.2 Controls for Use with ARPA

ENTER: Acquire cursor-selected target. Display data for tracked target (in the data box at the bottom of the screen).

CANCEL/HL OFF: Remove data of cursor-selected tracked target from the data box. Stop tracking the cursor-selected target (when its data is not displayed in the data box).

MENU: Access the [Target] and [ARPA] menus for ARPA operations.

Cursorpad: Select a target to acquire (or cancel the tracking). Select a target to show (or remove) target data.

3.3 ARPA Display On/Off

You can turn the ARPA display on or off. The system continuously tracks ARPA targets regardless of this setting.

1. Press the **MENU** key to open the menu.
2. Use the Cursorpad (▲ or ▼) to select [ARPA] and press the **ENTER** key.
3. Use the Cursorpad (▲ or ▼) to select [Display] and press the **ENTER** key.



ARPA-Display options

4. Use the Cursorpad (▲ or ▼) to select [Off] or [On] then press the **ENTER** key.
5. Press the **MENU** key to close the menu.

3.4 How to Acquire and Track the Targets

Ten targets are acquired and tracked manually or automatically.

3.4.1 Manual acquisition

You can acquire up to ten ARPA targets. When the automatic acquisition ([Auto Acquisition] on the [ARPA] menu) is set to on, you can manually acquire up to five targets.

1. Use the Cursorpad to put the cursor on the target to acquire.
2. Press the **ENTER** key.

The ARPA target symbol changes over time as below. A vector which indicates the motion direction of the target appears approximately one minute after acquisition.

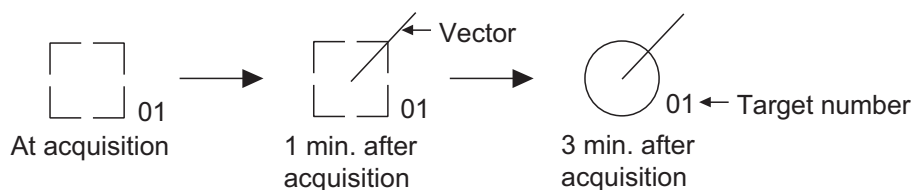

ARPA target symbol

Target number

River and Sea (Non-IEC system): An acquired target gets the youngest unused number. When a target is lost and disappears from the number list, the next acquired target takes the number of that lost target (ie; In a 5 target list, if the target 2 is lost, the next acquired target takes the number of target 2).

IEC and Russian-River (IEC system): An acquired target gets the youngest unused number. When a target is lost and disappears from the number list, the next acquired target takes the next sequential number until reaching a maximum 10. If the target number reaches a maximum 10, the next acquired target takes the number of a previously lost target.

3.4.2 Automatic acquisition

When you set an automatic acquisition area, the ARPA can acquire up to five targets automatically.

The automatic acquisition area is 2.0 to 2.5 nm in range and $\pm 45^\circ$ on either side of the heading line in bearing. When you change the automatic acquisition to manual acquisition, targets being tracked in automatic acquisition are continuously tracked.

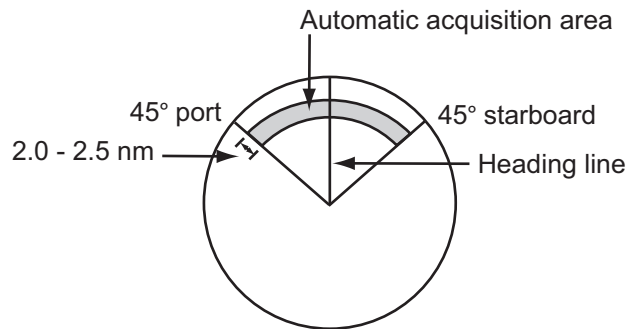

Automatic acquisition area

1. Press the **MENU** key to open the menu.
2. Use the Cursorpad (**▲** or **▼**) to select [ARPA] and press the **ENTER** key.
3. Use the Cursorpad (**▲** or **▼**) to select [Auto Acquisition] and press the **ENTER** key.



Auto Acquisition options

4. Use the Cursorpad (**▲** or **▼**) to select [On] and press the **ENTER** key.
5. Press the **MENU** key to close the menu.

3.5 How to Stop the Tracking of ARPA Target

When ten targets have been acquired, no more acquisition occurs unless targets are cancelled. If you acquire additional targets, you must cancel one or more individual targets, or all targets. Use one of the following procedures.

3.5.1 How to stop the tracking of selected targets

1. Use the Cursorpad to put the cursor on the target to cancel the tracking.
2. Press the **CANCEL/HL OFF** key to cancel the tracking and erase the ARPA symbol. The unit beeps twice and the symbol is erased from the screen.

3.5.2 How to stop the tracking of all targets

1. Press the **MENU** key to open the menu.
2. Use the Cursorpad (**▲** or **▼**) to select [ARPA] and press the **ENTER** key.

3. ARPA OPERATION

- Use the Cursorpad (▲ or ▼) to select [All Cancel] and press the **ENTER** key.

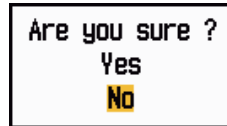

All Cancel options

- Use the Cursorpad (▲) to select [Yes] and press the **ENTER** key. All symbols are erased from the screen and the long beep sounds.
- Press the **MENU** key to close the menu.

3.6 Vector Attributes

3.6.1 What is a vector?

A vector is a line extending from a tracked target. A vector shows speed and course of the target. The top of a vector shows estimated position of the target after the selected vector time elapses. If you extend the vector length (time), you can evaluate the risk of collision with any target.

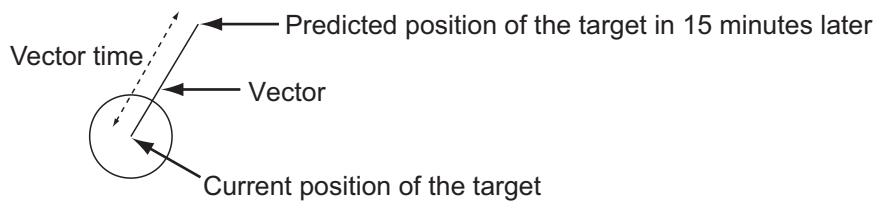

When vector time is 15 minutes

3.6.2 Vector time and vector reference

- Press the **MENU** key to open the menu.
- Use the Cursorpad (▲ or ▼) to select [Target] and press the **ENTER** key.

Menu	Target
Display	Vector Time : 6min
Echo	Vector Reference : True
Custom 1	History Dots : 5
Custom 2	History Interval : 1min
Custom 3	CPA : Off
Alarm	TCPA : 1min
Target Trails	Proximity : Off
Tuning	
Others	
Target	
ARPA	
	[ENTER]: Enter [CANCEL/HL OFF]: Back [MENU]: Exit

Adjusting a vector time to be displayed

Target menu

3. Use the Cursorpad (▲ or ▼) to select [Vector Time] and press the **ENTER** key.



Vector Time setting window

4. Use the Cursorpad (▲ or ▼) to select time and press the **ENTER** key.
 5. Use the Cursorpad (▲ or ▼) to select [Vector Reference] and press the **ENTER** key.



Vector Reference options

6. Use the Cursorpad (▲ or ▼) to select [Relative] or [True] then press the **ENTER** key. This function is not activate for [IEC] or [Russian-River] purpose. The mode is set to [True].
[Relative]: Other ships' vectors are displayed relative to your ship. This mode helps find targets on a collision course. If a ship is on a collision course with your ship, the vector of a ship points toward your ship position.
[True]: Your ship's and other ships' vectors are displayed at their true motions. This mode helps discriminate between moving and stationary targets.
7. Press the **MENU** key to close the menu.

Note: The functions of the [Target] menu are shared by ARPA and AIS.

3.6.3 Vector of your ship

The vector of your ship is shown as an arrow from your ship position. The vector of your ship is shown on the following conditions:

- Connect ARP-11 (option)
- Select [True] on the menu item [Vector Reference] on the [Target] menu
- Independent of on/off on the menu item [Display] on the [ARPA] menu

Note: The vector of your ship is shown in the same color as the ARPA symbol color (see section 3.12).

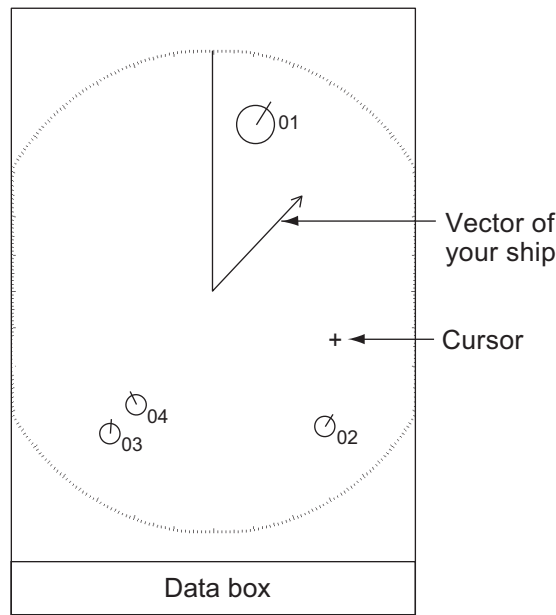

3.7 History Display (target past position)

This radar can display time-spaced dots (maximum ten dots) that mark the past positions of any tracked ARPA target. You can evaluate actions of a target by the spacing between dots. Below are examples of dot spacing and target movement.

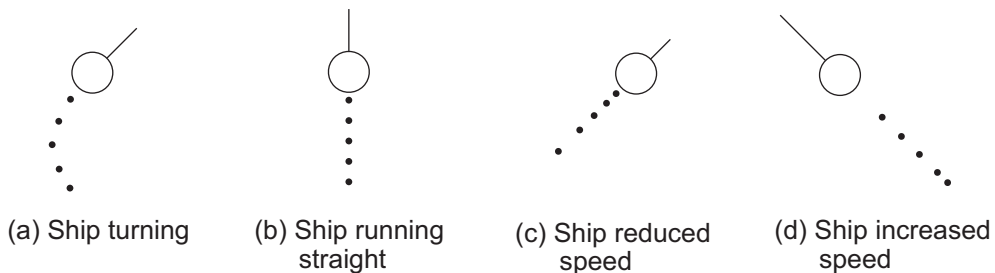

Target movement and history display

You can select the number of history dots to display and the time interval to display the history dots.

1. Press the **MENU** key to open the menu.
2. Use the Cursorpad (▲ or ▼) to select [Target] and press the **ENTER** key.
3. Use the Cursorpad (▲ or ▼) to select [History Dots] and press the **ENTER** key.

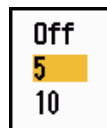

History Dots options

4. Use the Cursorpad (▲ or ▼) to select number of history dots to display (5 or 10) or select [Off] to turn off the history display.
5. Press the **ENTER** key.

6. Use the Cursorpad (▲ or ▼) to select [History Interval] and press the **ENTER** key.

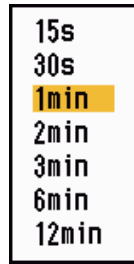

History Interval options

7. Use the Cursorpad (▲ or ▼) to select the time interval and press the **ENTER** key.
8. Press the **MENU** key to close the menu.

3.8 ARPA Target Data

You can show the data for a tracked ARPA target in the data box at the bottom of the screen. To display ARPA target data, the menu item [Display] on the [ARPA] menu must be set for [On] and the menu item [Data Box] on the [Display] menu must be set for [Target] or [All].

1. Use the Cursorpad to put the cursor on an ARPA target.
2. Press the **ENTER** key to show the data of the target.

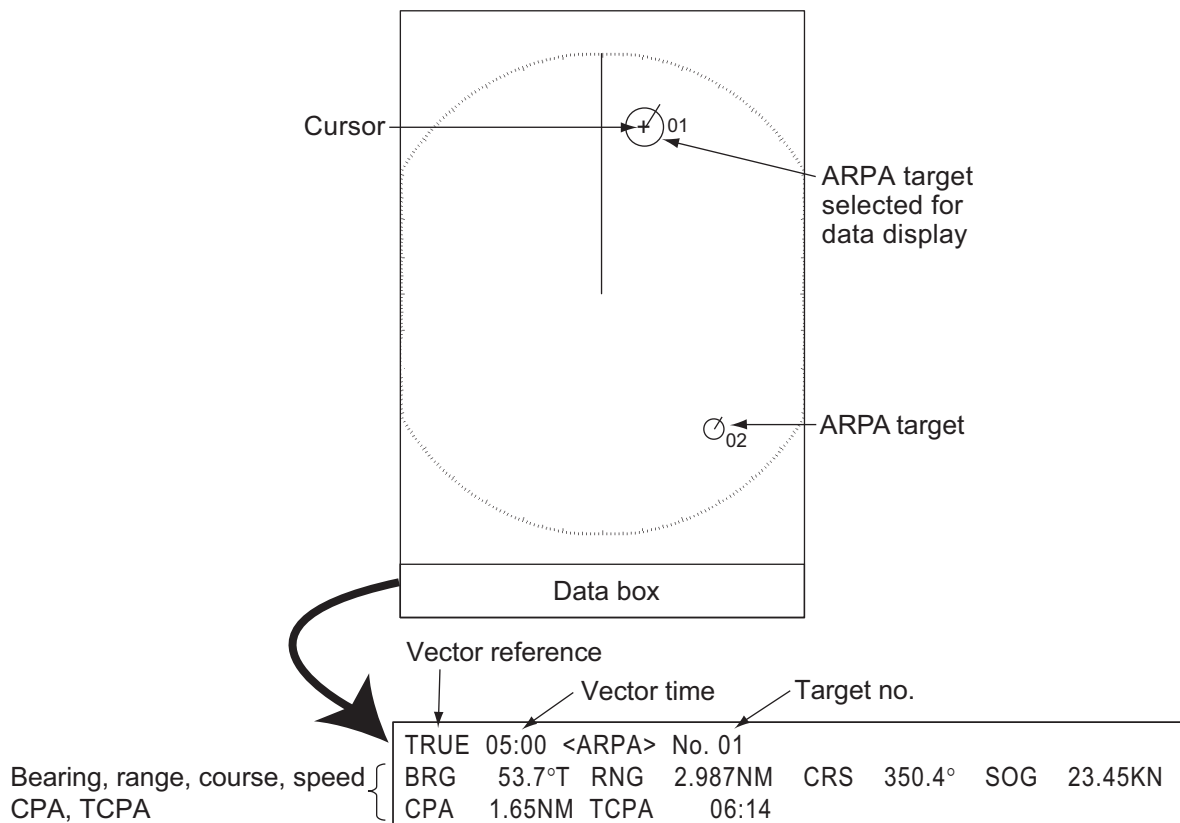

ARPA target data

The symbol for the selected ARPA target is enlarged double to distinguish from other symbols.

To remove the data of a target from a data box, put the cursor on its target symbol and press the **CANCEL/HL OFF** key.

3.9 CPA/TCPA Alarm

Set CPA (Closest Point of Approach) alarm range and TCPA (predicted Time to CPA) alarm time to alert you to targets that can be on a collision course. When CPA and TCPA of any ARPA target become less than the preset CPA and TCPA alarm settings, the audio alarm sounds. The alarm message "COLLISION" appears. The target symbol changes to a dangerous target symbol (triangle) and flashes with its vector. You can stop the audio alarm with any key. The flashing of the triangle stops when the tracked ARPA target is not in the CPA and TCPA alarm setting. The ARPA continuously monitors CPA and TCPA of all tracked ARPA targets.



Dangerous target symbol

This feature helps identify targets that can be on a collision course. Correctly adjust **GAIN, A/C SEA, A/C RAIN** and other radar controls.

 CAUTION
<p>Do not depend on the CPA/TCPA alarm as the only method to detect the risk of collision. The navigator is not released of the responsibility to keep visual caution for collision situations, whether or not the radar or other plotting aid is in use.</p>

1. Press the **MENU** key to open the menu.
2. Use the Cursorpad (▲ or ▼) to select [Target] and press the **ENTER** key.
3. Use the Cursorpad (▲ or ▼) to select [CPA] and press the **ENTER** key.

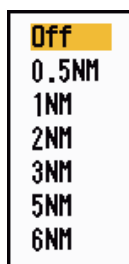

CPA options

4. Use the Cursorpad (▲ or ▼) to select CPA distance and press the **ENTER** key.

- Use the Cursorpad (▲ or ▼) to select [TCPA] and press the **ENTER** key.

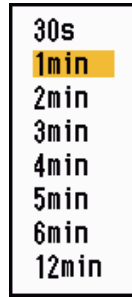

TCPA options

- Use the Cursorpad (▲ or ▼) to select TCPA and press the **ENTER** key.
- Press the **MENU** key to close the menu.

3.10 Proximity Alarm

The proximity alarm alerts you when an ARPA target is within the range you set. The audio alarm sounds and the alarm message "PROXIMITY" appears. The target symbol changes to a dangerous target symbol (triangle, see section 3.9) and flashes with its vector. Press any key to stop the audio alarm. The flashing continues until the target is not within the range set, the alarm range is changed to exclude the target, or the proximity alarm is deactivated.

- Press the **MENU** key to open the menu.
- Use the Cursorpad (▲ or ▼) to select [Target] and press the **ENTER** key.
- Use the Cursorpad (▲ or ▼) to select [Proximity] and press the **ENTER** key.

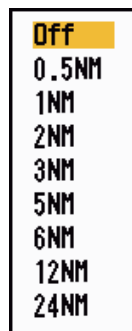

Proximity options

- Use the Cursorpad (▲ or ▼) to select the range and press the **ENTER** key.
- Press the **MENU** key to close the menu.

3.11 Lost Target

When the system detects a lost target, the audio alarm sounds and the alarm message "LOST" appears. The target symbol becomes a flashing square like the following illustration. When the system detects the target again, the target symbol becomes a normal symbol.

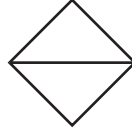

Lost target symbol

To erase a lost target symbol, put the cursor on the symbol and press the **CANCEL/HL OFF** key. If you leave a lost target symbol flashing, the symbol disappears after one minute.

You can remove all lost ARPA targets from the screen as follows:

1. Press the **MENU** key to open the menu.
2. Use the Cursorpad (▲ or ▼) to select [ARPA] and press the **ENTER** key.
3. Use the Cursorpad (▲ or ▼) to select [ACK Lost Targets] and press the **ENTER** key.

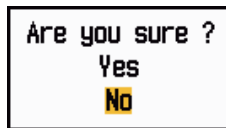

ACK Lost Targets options

4. Use the Cursorpad (▲) to select [Yes] and press the **ENTER** key. All lost targets symbols are erased from the screen and the long beep sounds.
5. Press the **MENU** key to close the menu.

3.12 Symbol Color

You can select the ARPA symbol color from Green, Red, Blue, White or Black.

1. Press the **MENU** key to open the menu.
2. Use the Cursorpad (▲ or ▼) to select [ARPA] and press the **ENTER** key.
3. Use the Cursorpad (▲ or ▼) to select [Color] and press the **ENTER** key.



Color options

4. Use the Cursorpad (▲ or ▼) to select the color and press the **ENTER** key.
5. Press the **MENU** key to close the menu.

Note: Symbols can not be shown in the same color as the background color.

4. AIS OPERATION

Connected to the FURUNO AIS Transponders FA-150, FA-100, FA-50 or the AIS Receiver FA-30, the MODEL 1835 series can show the name, position and other navigation data of the nearest 100 AIS transponder-equipped ships.

This radar accepts position data fixed by WGS-84 geodetic datum. Set the datum to WGS-84 on the GPS navigator connected to this radar. If this radar is interfaced with the FURUNO GPS Navigator GP-320B, see section 5.2 for the procedure.

4.1 Controls for Use with AIS

ENTER: Activate cursor-selected target. Display data for selected active target (in the data box at the bottom of the screen).

CANCEL/HL OFF: Remove data of cursor-selected AIS target from the data box. Sleep cursor-selected target (when its data is not displayed in the data box).

MENU: Access the [Target] and [AIS] menus for AIS operations.

Cursorpad: Select a target to activate (or sleep). Select a target to show (or remove) target data.

4.2 AIS Display On/Off

You can turn the AIS display on or off. The system continues processing AIS targets regardless of on/off for AIS display when the AIS transponder is turned on.

1. Press the **MENU** key to open the menu.
2. Use the Cursorpad (**▲** or **▼**) to select [AIS] and press the **ENTER** key.

Menu	AIS
Custom 1	Display : Off
Custom 2	Color : Green
Custom 3	Number of Targets : 30
Alarm	Sort By : Range
Target Trails	Range : 24.0NM
Tuning	Sector Start : 340°
Others	Sector End : 20°
Target	Ignore Slow Targets : 5.0kn
ARPA	ACK Lost Targets
AIS	[ENTER]: Enter [CANCEL/HL OFF]: Back
GPS	[MENU]: Exit

Turning on/off AIS display

AIS menu

4. AIS OPERATION

- Use the Cursorpad (▲ or ▼) to select [Display] and press the **ENTER** key.



AIS-Display options

- Use the Cursorpad (▲ or ▼) to select [Off] or [On] then press the **ENTER** key.
- Press the **MENU** key to close the menu.

4.3 AIS Symbols

When the AIS is turned on, AIS targets are displayed with AIS symbol as below.



AIS symbols

Note: The AIS symbols are momentarily erased after the screen is redrawn when the heading is changed on the head-up mode.

4.4 Activating, Sleeping Targets

When you change a sleeping target to an activated target, a vector shows the course and speed of that target. You can easily judge the target movement by the vector.

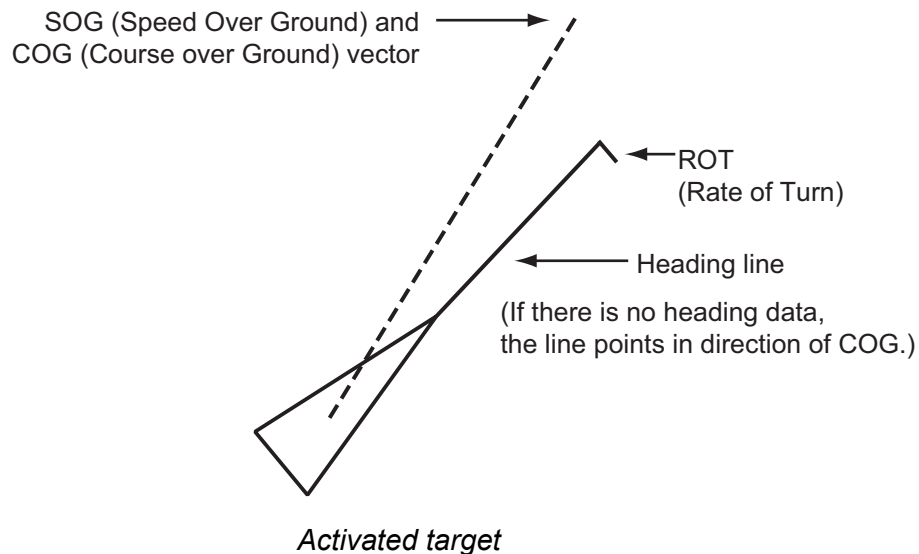

When there are many activated targets on the screen, you can not easily distinguish the activated targets from the radar images or ARPA targets. You can sleep an activated target for easy view of radar images.

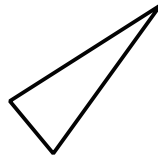

Sleeping target

To activate a target: Put the cursor on the target and press the **ENTER** key.

To sleep a target: Put the cursor on the target and press the **CANCEL HL/OFF** key.

4.5 AIS Target Data

You can show the AIS target data in the data box at the bottom of the screen. To display AIS target data, the menu item [Display] on the [AIS] menu must be set for [On] and the menu item [Data Box] on the [Display] menu must be set for [Target] or [All].

1. Use the Cursorpad to put the cursor on an activated target.
2. Press the **ENTER** key to show the data of the target.

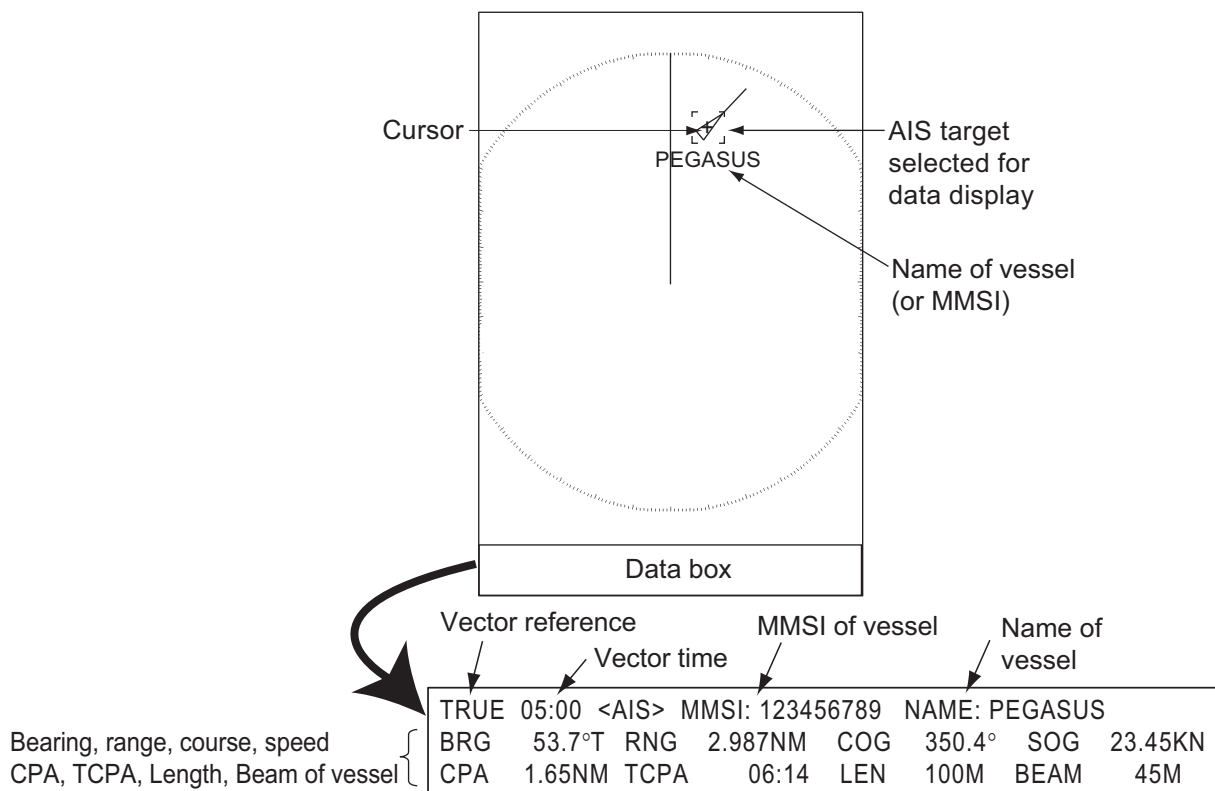

AIS target data

To remove the target data from a data box, put the cursor on its target symbol and press the **CANCEL/HL OFF** key.

4.6 How to Sort Targets

You can sort the AIS targets received from the AIS transponder by range from your ship, by sector, by CPA or TCPA.

1. Press the **MENU** key to open the menu.
2. Use the Cursorpad (▲ or ▼) to select [AIS] and press the **ENTER** key.
3. Use the Cursorpad (▲ or ▼) to select [Sort By] and press the **ENTER** key.

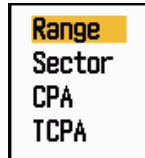

Sort By options

4. Use the Cursorpad (▲ or ▼) to select sorting method and press the **ENTER** key.
 - [Range]:** Sort targets within the display range set (see section 4.7), from nearest to furthest.
 - [Sector]:** Sort targets within the display sector set (see section 4.8) and within 24 nm, from nearest to furthest.
 - [CPA]:** Sort targets within 24 nm by CPA, from closest to furthest.
 - [TCPA]:** Sort targets within 24 nm by TCPA, from earliest time to latest time.
5. Press the **MENU** key to close the menu.

4.7 Display Range

You can set the AIS system to show only those AIS targets within the range you set. The setting range is 0.1-36 nm for MODEL 1835, 0.1-48 nm for MODEL 1935, 0.1-64 nm for MODEL 1945. Actual range depends on the AIS Transponder. If the target sorting method is selected to [Range], the target data within the range set here is transmitted to this radar.

1. Press the **MENU** key to open the menu.
2. Use the Cursorpad (▲ or ▼) to select [AIS] and press the **ENTER** key.
3. Use the Cursorpad (▲ or ▼) to select [Range] and press the **ENTER** key.

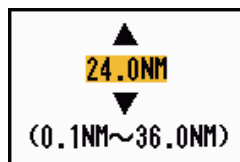

AIS-Range setting window (for MODEL 1835)

4. Use the Cursorpad (▲ or ▼) to set the display range and press the **ENTER** key.
5. Press the **MENU** key to close the menu.

Note: The unit of measurement for range is NM.

4.8 How to Display the Targets within a Specific Sector

You can display AIS targets only within a specific sector. If the target sorting method is selected to [Sector], the target data within the sector set here is transmitted to this radar.

1. Press the **MENU** key to open the menu.
2. Use the Cursorpad (▲ or ▼) to select [AIS] and press the **ENTER** key.
3. Use the Cursorpad (▲ or ▼) to select [Sector Start] and press the **ENTER** key.

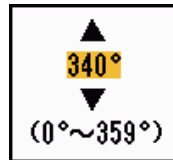

Sector Start setting window

4. Use the Cursorpad (▲ or ▼) to set the start point for the sector and press the **ENTER** key.
5. Use the Cursorpad (▲ or ▼) to select [Sector End] and press the **ENTER** key.

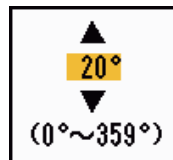

Sector End setting window

6. Use the Cursorpad (▲ or ▼) to set the end point for the sector and press the **ENTER** key.
7. Press the **MENU** key to close the menu.

4.9 Number of Targets to Display

You can select the maximum number of AIS targets to display. The setting value is 10 to 100. When the screen becomes cluttered with AIS targets, you can limit the number of AIS targets to show. Targets are selected and displayed according to sort method. (See section 4.6.)

1. Press the **MENU** key to open the menu.
2. Use the Cursorpad (▲ or ▼) to select [AIS] and press the **ENTER** key.
3. Use the Cursorpad (▲ or ▼) to select [Number of Targets] and press the **ENTER** key.

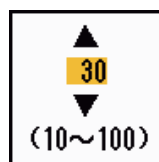

Number of Targets setting window

4. AIS OPERATION

4. Use the Cursorpad (▲ or ▼) to select the number of targets to display and press the **ENTER** key.
5. Press the **MENU** key to close the menu.

4.10 Vector Attributes

4.10.1 What is a vector?

A vector is a line extending from a tracked target. A vector shows speed and course of the target. The top of a vector shows estimated position of the target after the selected vector time elapses. If you extend the vector length (time), you can evaluate the risk of collision with any target.

4.10.2 Vector time and vector reference

1. Press the **MENU** key to open the menu.
2. Use the Cursorpad (▲ or ▼) to select [Target] and press the **ENTER** key.
3. Use the Cursorpad (▲ or ▼) to select [Vector Time] and press the **ENTER** key.



Vector Time setting window

4. Use the Cursorpad (▲ or ▼) to select time and press the **ENTER** key.
5. Use the Cursorpad (▲ or ▼) to select [Vector Reference] and press the **ENTER** key.

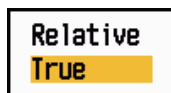

Vector Reference options

6. Use the Cursorpad (▲ or ▼) to select [Relative] or [True] then press the **ENTER** key. This function is not activate for [IEC] or [Russian-River] purpose. The mode is set to [True].
[Relative]: Other ships' vectors are displayed relative to your ship. This mode helps find targets on a collision course. If a ship is on a collision course with your ship, the vector of a ship points toward your ship position.
[True]: Your ship's and other ships' vectors are displayed at their true motions. This mode helps discriminate between moving and stationary targets.
7. Press the **MENU** key to close the menu.

4.11 History Display (target past position)

This radar can display time-spaced dots (maximum ten dots) that marks the past positions of any tracked AIS target. You can evaluate actions of a target by the spacing between dots. Below are examples of dot spacing and target movement.

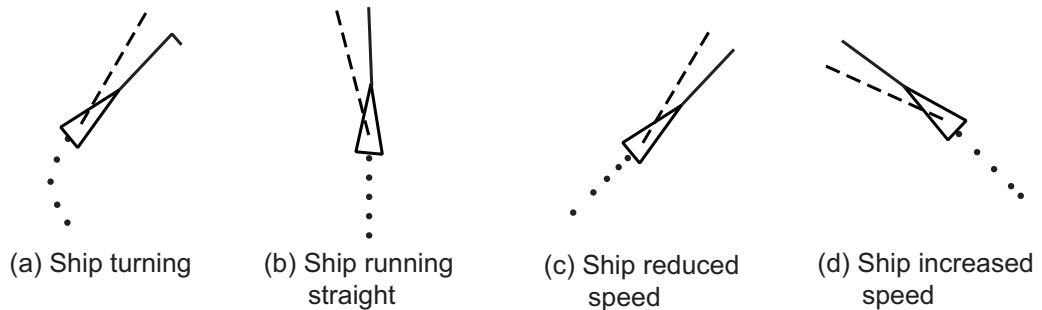

Target movement and history display

You can select the number of history dots to display and the time interval to display the history dots.

1. Press the **MENU** key to open the menu.
2. Use the Cursorpad (▲ or ▼) to select [Target] and press the **ENTER** key.
3. Use the Cursorpad (▲ or ▼) to select [History Dots] and press the **ENTER** key.

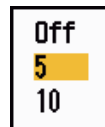

History Dots options

4. Use the Cursorpad (▲ or ▼) to select number of history dots to display (5 or 10) or select [Off] to turn off the history display.
5. Press the **ENTER** key.
6. Use the Cursorpad (▲ or ▼) to select [History Interval] and press the **ENTER** key.



History Interval options

7. Use the Cursorpad (▲ or ▼) to select time interval and press the **ENTER** key.
8. Press the **MENU** key to close the menu.

4.12 CPA/TCPA Alarm

Set CPA (Closest Point of Approach) alarm range and TCPA (predicted Time to CPA) alarm time to alert you to targets that can be on a collision course. When CPA and TCPA of any AIS target (including a sleeping target) become less than the preset CPA and TCPA alarm settings, the audio alarm sounds. The alarm message "COLLISION" appears. The target symbol changes to a dangerous target symbol (red) and flashes with its vector. You can stop the audio alarm and flashing with any key. The dangerous target symbol is displayed until the AIS target is not in the CPA and TCPA alarm setting. The AIS continuously monitors CPA and TCPA of all AIS targets.

This feature helps identify targets that can be on a collision course.

1. Press the **MENU** key to open the menu.
2. Use the Cursorpad (▲ or ▼) to select [Target] and press the **ENTER** key.
3. Use the Cursorpad (▲ or ▼) to select [CPA] and press the **ENTER** key.

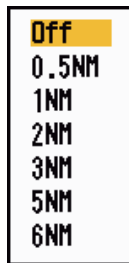

CPA options

4. Use the Cursorpad (▲ or ▼) to select CPA distance and press the **ENTER** key.
5. Use the Cursorpad (▲ or ▼) to select [TCPA] and press the **ENTER** key.

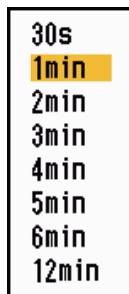

TCPA options

6. Use the Cursorpad (▲ or ▼) to select TCPA and press the **ENTER** key.
7. Press the **MENU** key to close the menu.

4.13 Proximity Alarm

The proximity alarm alerts you when an AIS target is within the range you set. The audio alarm sounds and the alarm message "PROXIMITY" appears. The target symbol changes to a dangerous target symbol (red) and flashes with its vector. Press any key to stop the audio alarm and flashing. The dangerous target symbol is displayed until the target is not within the range set, the alarm range is changed to exclude the target, or the proximity alarm is deactivated.

1. Press the **MENU** key to open the menu.
2. Use the Cursorpad (▲ or ▼) to select [Target] and press the **ENTER** key.
3. Use the Cursorpad (▲ or ▼) to select [Proximity] and press the **ENTER** key.

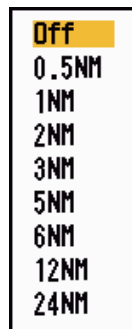

Proximity options

4. Use the Cursorpad (▲ or ▼) to select the range and press the **ENTER** key.
5. Press the **MENU** key to close the menu.

4.14 Lost Target

When AIS data is not received from a target at fixed interval (3-5* report intervals), the target symbol changes to the lost target symbol (flashing). No audio or visual alarm is given for a lost target.



Lost target symbol

* The interval at which AIS data is sent depends on speed of the AIS transponder. For detailed information, refer to the Operator's Manual for the AIS transponder.

You can remove all lost AIS targets from the display as follows:

1. Press the **MENU** key to open the menu.
2. Use the Cursorpad (▲ or ▼) to select [AIS] and press the **ENTER** key.
3. Use the Cursorpad (▲ or ▼) to select [ACK Lost Targets] and press the **ENTER** key.

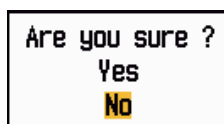

ACK Lost Targets options

4. AIS OPERATION

4. Use the Cursorpad (▲) to select [Yes] and press the **ENTER** key. All lost targets symbols are erased from the screen and the long beep sounds.
5. Press the **MENU** key to close the menu.

4.15 Symbol Color

You can select the AIS symbol color among Green, Red (unavailable in the [IEC] or [Russian-River] purpose), Blue, White or Black.

1. Press the **MENU** key to open the menu.
2. Use the Cursorpad (▲ or ▼) to select [AIS] and press the **ENTER** key.
3. Use the Cursorpad (▲ or ▼) to select [Color] and press the **ENTER** key.



Color options

4. Use the Cursorpad (▲ or ▼) to select the color and press the **ENTER** key.
5. Press the **MENU** key to close the menu.

Note: Symbols can not be shown in the same color as the background color.

4.16 How to Ignore Slow Targets

You can prevent activation of the CPA/TCPA alarm against AIS targets that are traveling at a speed lower than set here. The AIS symbols are not affected by this setting.

1. Press the **MENU** key to open the menu.
2. Use the Cursorpad (▲ or ▼) to select [AIS] and press the **ENTER** key.
3. Use the Cursorpad (▲ or ▼) to select [Ignore Slow Targets] and press the **ENTER** key.

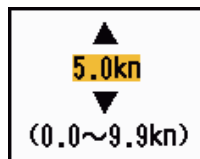

Ignore Slow Targets setting window

4. Use the Cursorpad (▲ or ▼) to select speed (0.0 - 9.9 kn) and press the **ENTER** key.
5. Press the **MENU** key to close the menu.

5. GPS OPERATION

If the FURUNO GPS Navigator GP-320B is connected to this radar, you can set GP-320B from this radar.

5.1 Navigator Mode

1. Press the **MENU** key to open the menu.
2. Use the Cursorpad (▲ or ▼) to select [GPS] and press the **ENTER** key.
3. Use the Cursorpad (▲ or ▼) to select [Mode] and press the **ENTER** key.



Mode options

4. Use the Cursorpad (▲ or ▼) to select [GPS] or [WAAS] then press the **ENTER** key.
5. Press the **MENU** key to close the menu.

5.2 Datum

Select the type of datum which matches the paper charts you use for navigation. Select [WGS-84] if the radar is connected to an AIS Transponder.

1. Press the **MENU** key to open the menu.
2. Use the Cursorpad (▲ or ▼) to select [GPS] and press the **ENTER** key.
3. Use the Cursorpad (▲ or ▼) to select [Datum] and press the **ENTER** key.



Datum options

4. Use the Cursorpad (▲ or ▼) to select the type of datum and press the **ENTER** key. If you select [WGS-84] or [Tokyo], go to step 7. If you select [Other], go to the next step.
5. Use the Cursorpad (▲ or ▼) to select [Datum No] and press the **ENTER** key.



Datum No setting window

6. Use the Cursorpad (▲ or ▼) to select the datum number and press the **ENTER** key. (The setting range is 001 - 192 and 201 - 254. Refer to the appendix 2 "GEODETIC CHART LIST".)
7. Press the **MENU** key to close the menu.

5.3 WAAS Setup

Geostationary satellites, the type used with WAAS, provide more accurate position data when compared to GPS. These satellites can be tracked automatically or manually. Auto tracking automatically searches for the best geostationary satellite from your current position.

1. Press the **MENU** key to open the menu.
2. Use the Cursorpad (▲ or ▼) to select [GPS] and press the **ENTER** key.
3. Use the Cursorpad (▲ or ▼) to select [WAAS] and press the **ENTER** key.



WAAS options

4. Use the Cursorpad (▲ or ▼) to select [Auto] or [Manual] then press the **ENTER** key. If you select [Auto], go to step 7. If you select [Manual], go to the next step.
5. Use the Cursorpad (▲ or ▼) to select [WAAS No] and press the **ENTER** key.



WAAS No setting window

6. Use the Cursorpad (▲ or ▼) to select WAAS number and press the **ENTER** key. (The setting range is 120 - 158. Refer to the following table.)
7. Press the **MENU** key to close the menu.

Provider	Satellite type	Longitude	Satellite No.
WAAS	Inmarsat-3-F4 (AOR-W)	142°W	122
	Inmarsat-3-F3 (POR)	178°E	134
	Intelsat Galaxy XV	133°W	135
	TeleSat Anik F1R	107.3°W	138
EGNOS	Inmarsat-3-F2 (AOR-E)	15.5°W	120
	Artemis	21.5°E	124
	Inmarsat-3-F5 (IOR-W)	25°E	126
MSAS	MTSAT-1R	140°E	129
	MTSAT-2	145°E	137

5.4 Satellite Monitor

The Satellite Monitor provides the information about GPS and WAAS satellites. See your GPS navigator's owner's manual for detailed information.

1. Press the **MENU** key to open the menu.
2. Use the Cursorpad (**▲** or **▼**) to select [GPS] and press the **ENTER** key.
3. Use the Cursorpad (**▲** or **▼**) to select [Satellite Monitor] and press the **ENTER** key.

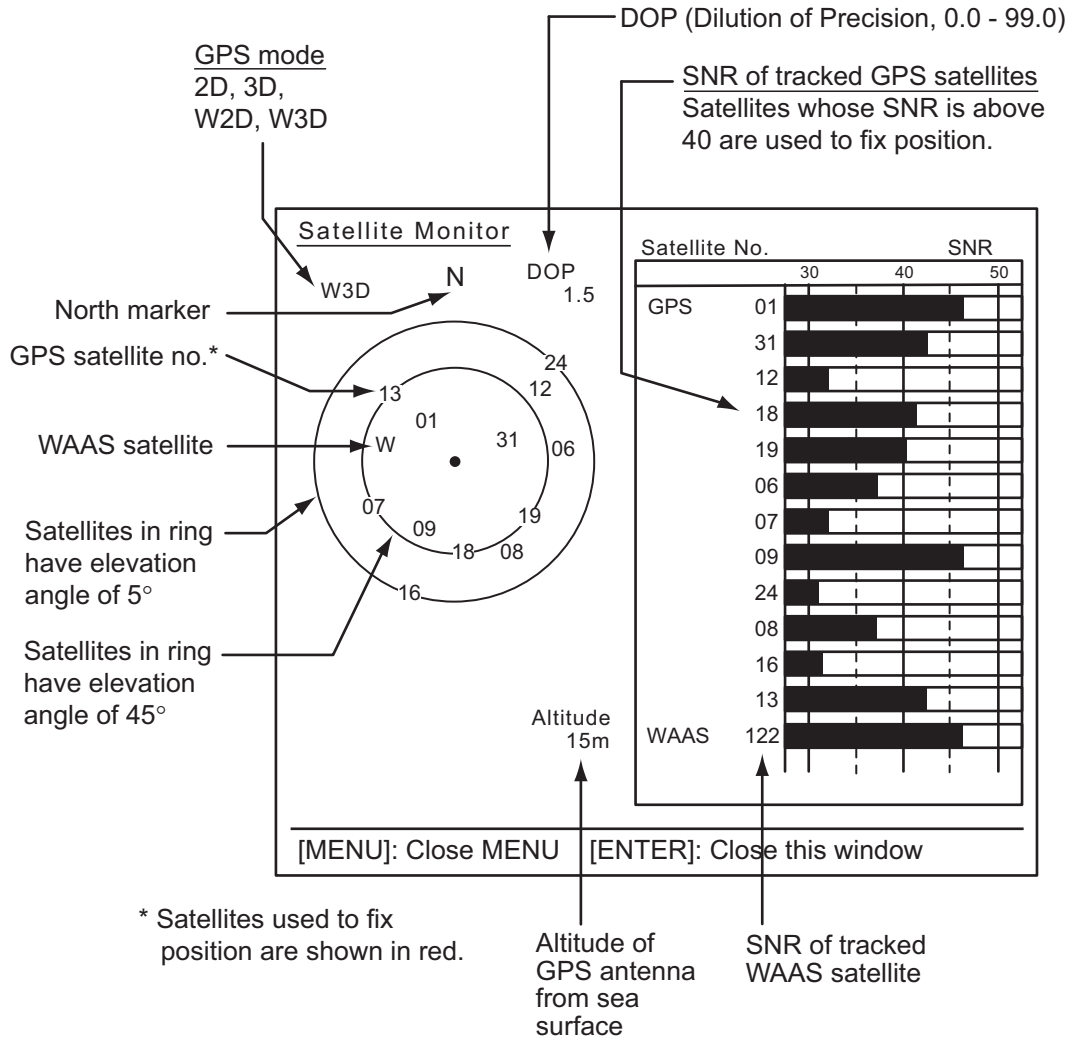

Satellite monitor

4. Press the **ENTER** key to close only the satellite monitor display.

5.5 Cold Start

Cold start, which clears the Almanac from the GPS receiver, can be necessary in the following conditions:

- If you have turned off the power of the GPS receiver for a long time.
- The ship has moved far away from the previous fixing position (e.g., more than 500 km).
- Other reason that prevents the receiver from finding its position within five minutes after you turn on the power.

To do cold start, do the following:

1. Press the **MENU** key to open the menu.
2. Use the Cursorpad (▲ or ▼) to select [GPS] and press the **ENTER** key.
3. Use the Cursorpad (▲ or ▼) to select [Cold Start] and press the **ENTER** key.

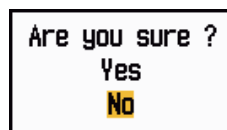





Cold Start options

4. Use the Cursorpad (▲) to select [Yes] and press the **ENTER** key. After processing cold start, the long beep sounds. (To stop cold start, press the **CANCEL/HL OFF** key instead of the **ENTER** key.)
5. Press the **MENU** key to close the menu.

6. MAINTENANCE, TROUBLE-SHOOTING

This chapter has information about maintenance and troubleshooting that the user can follow to care for the equipment.

 WARNING	
	ELECTRICAL SHOCK HAZARD Do not open the equipment. Only qualified personnel can work inside the equipment.
	Turn off the power before you service the antenna unit. Post a warning sign near the power switch not to turn on the power while you service the antenna unit.
	Prevent the potential risk of being struck by the rotating antenna and exposure to RF radiation hazard.
	When you work on the antenna unit, wear a safety belt and hard hat. Serious injury or death can result if a person falls from the radar antenna mast.

NOTICE
Do not apply paint, anti-corrosive sealant or contact spray to plastic parts or equipment coating. Those items contain products that can damage plastic parts and equipment coating.

6.1 Preventive Maintenance

Regular maintenance helps keep your equipment in good condition and prevents future problems. Check the items shown in the table below to help keep your equipment in good condition for years to come.

Maintenance

Interval	Item	Check point	Remedy
When necessary	LCD	Dust on the LCD	Remove the dust from the LCD with the tissue paper and an LCD cleaner. To remove dirt or salt, use the LCD cleaner. Change the tissue paper often so as not to scratch the LCD.
3 to 6 months	Ground terminal on display unit	Check for tight connection and rust.	Tighten or replace as necessary.
	Display unit connectors	Check for tight connection.	Tighten if the connectors are loosened.
	Exposed nuts and bolts on the antenna unit	Check for corroded or loosened bolts.	Clean and repaint as necessary. Use sealing compound instead of paint.
	Antenna radiator	Check for dirt and cracks on the radiator surface.	Clean radiator surface with fresh-water-moistened cloth. Do not use plastic solvents to clean.

6.2 Fuse Replacement

The fuse on the power cable protects the equipment from overcurrent and equipment fault. If the fuse blows, find the cause before you replace the fuse. Use the correct fuse. A wrong fuse can damage the equipment.

WARNING

Use the correct fuse.

A wrong fuse can damage the equipment and cause fire.

Unit	Type	Code No.	Remarks
Display unit (fitted on power cable)	FGB0 125V 10A PBF	000-155-826-10	12 VDC
	FGB0-A 125V 5A PBF	000-155-853-10	24 VDC

6.3 Magnetron Life

When the life of the magnetron is reached, the targets do not appear on the display. If long-range performance appears to have decreased, contact a FURUNO agent or dealer about replacement of the magnetron. The magnetron changes with the type of antenna unit.

Antenna unit: RSB-0071-057, XN10A-RSB-0070-064, XN10A-RSB-0073-064, XN12A-RSB-0070-059, XN12A-RSB-0073-059

Model	Magnetron type	Code No.	Estimated life
MODEL1835 MODEL1935	MAF1421B	000-158-786-11	Approx. 3,000 hours
	MG4004	000-158-895-10	
	E3571	000-146-867-11	Approx. 2,000 hours
MODEL1945	MAF1422B	000-158-788-12	Approx. 3,000 hours
	MG4006	000-158-896-10	

Antenna unit: RSB-0071-057A, XN10A-RSB-0070-064A, XN10A-RSB-0073-064A, XN12A-RSB-0070-059A, XN12A-RSB-0073-059A

Model	Magnetron type	Code No.	Estimated life
MODEL1835 MODEL1935	E3571	000-146-867-11	Approx. 2,000 hours
MODEL1945	MAF1422B	000-158-788-12	Approx. 3,000 hours

6.4 Simple Troubleshooting

This section provides simple troubleshooting procedures which the user can follow to restore normal operation. If you cannot restore normal operation, do not check inside the unit. Have a qualified technician check the equipment.

Simple troubleshooting

Problem	Remedy
You cannot turn on the power.	<ul style="list-style-type: none"> • Check for blown fuse. • Check that the power connector is fastened. • Check for corrosion on the power cable connector. • Check for damaged power cable. • Check battery for correct voltage output.
There is no response when a key is pressed.	Turn off and on the power. If you do not get a response, the key is damaged. Contact your dealer for instructions.
The power is on and you operated the STBY/TX key to transmit. The marks and letters appear, but no echo appears.	Check that the antenna cable is fastened.
Tuning is correctly adjusted, but sensitivity is poor.	Replace the magnetron. Contact your dealer.
The range is changed, but radar picture does not change.	<ul style="list-style-type: none"> • Try to hit the RANGE key again. • Turn off and on the display unit.
Poor discrimination in range because of many echoes from the waves.	Adjust A/C SEA control.
The true motion presentation is not working correctly.	<ul style="list-style-type: none"> • Check that the setting of [Display Mode] in the [Display] menu is set to [True Motion]. • Check if the heading and position data are input and correct.
The range rings are not displayed.	Check that the setting of [Rings Brill] in the [Brill/Color] menu is set to other than [Off].
Target is not tracked correctly because of sea clutter.	Adjust A/C SEA and A/C RAIN controls.

6.5 Advanced-level Troubleshooting

This section describes how to cure hardware and software troubles which the qualified service persons must do.

Advanced-level troubleshooting

Problem	Probable cause or check points	Remedy
Power cannot be turned on.	1) Mains voltage/polarity 2) Power supply board	1) Correct the wiring and input voltage. 2) Replace power supply board.
Brilliance adjusted but no picture.	1) SPU Board	1) Replace SPU board.
Antenna not rotating.	1) Antenna drive mechanism	1) Replace the antenna drive mechanism.
Data and marks not displayed in transmit.	1) SPU board	1) Replace SPU board.
Set GAIN to maximum with A/C SEA set at minimum. Marks and indications appear but no noise or echo.	1) Signal cable between antenna and display unit 2) IF amplifier 3) Video amplifier board	1) Check continuity and isolation of coaxial cable. 2) Replace IF amplifier. 3) Check coax line for fasten connection. If connection is good, replace SPU board.
Marks, indications and noise appear but no echo. (Transmission leak representing your ship position is absent.)	1) Magnetron 2) Modulator board 3) SPU board	1) Check magnetron current. 2) Replace modulator board. 3) Replace SPU board.
Picture not updated or picture freeze-up.	1) Bearing signal generator 2) SPU board 3) Video freeze-up	1) Check that signal cables are fastened. 2) Replace SPU board. 3) Turn off and on the radar.

6. MAINTENANCE, TROUBLESHOOTING

Problem	Probable cause or check points	Remedy
Radar is correctly tuned but sensitivity is poor.	1) [2nd Echo Rejector] is [On] 2) Dirt on radiator face 3) Deteriorated magnetron 4) Detuned MIC	1) Turn off the [2nd Echo Rejector], from the [Echo] menu. 2) Clean radiator. 3) Check the magnetron current with the radar transmitting on 48 nm range. If the current is below normal, magnetron may be defective. Replace the magnetron. 4) Check MIC detecting current. If MIC detecting current is below normal value, MIC may have become detuned.
Range changed but radar picture does not change.	1) RANGE key has faults 2) SPU board 3) Video freeze-up	1) Try to operate the RANGE key. If you can not operate the RANGE key, replace the keypad. 2) Replace SPU board. 3) Turn off and on radar.
Range rings are not displayed.	1) Adjust their brilliance on the [Brill/Color] menu. 2) SPU Board	1) Replace associated circuit board if unsuccessful. 2) Replace SPU Board.

6.6 Diagnostic Test

The diagnostic test checks the system for correct operation. This test is for use by service technicians, but the user can do this test to provide the service technician with information.

1. Press the **MENU** key to open the menu.
2. Use the Cursorpad (▲ or ▼) to select [Tests] and press the **ENTER** key.
3. Use the Cursorpad (▲ or ▼) to select [Self Test] and press the **ENTER** key.

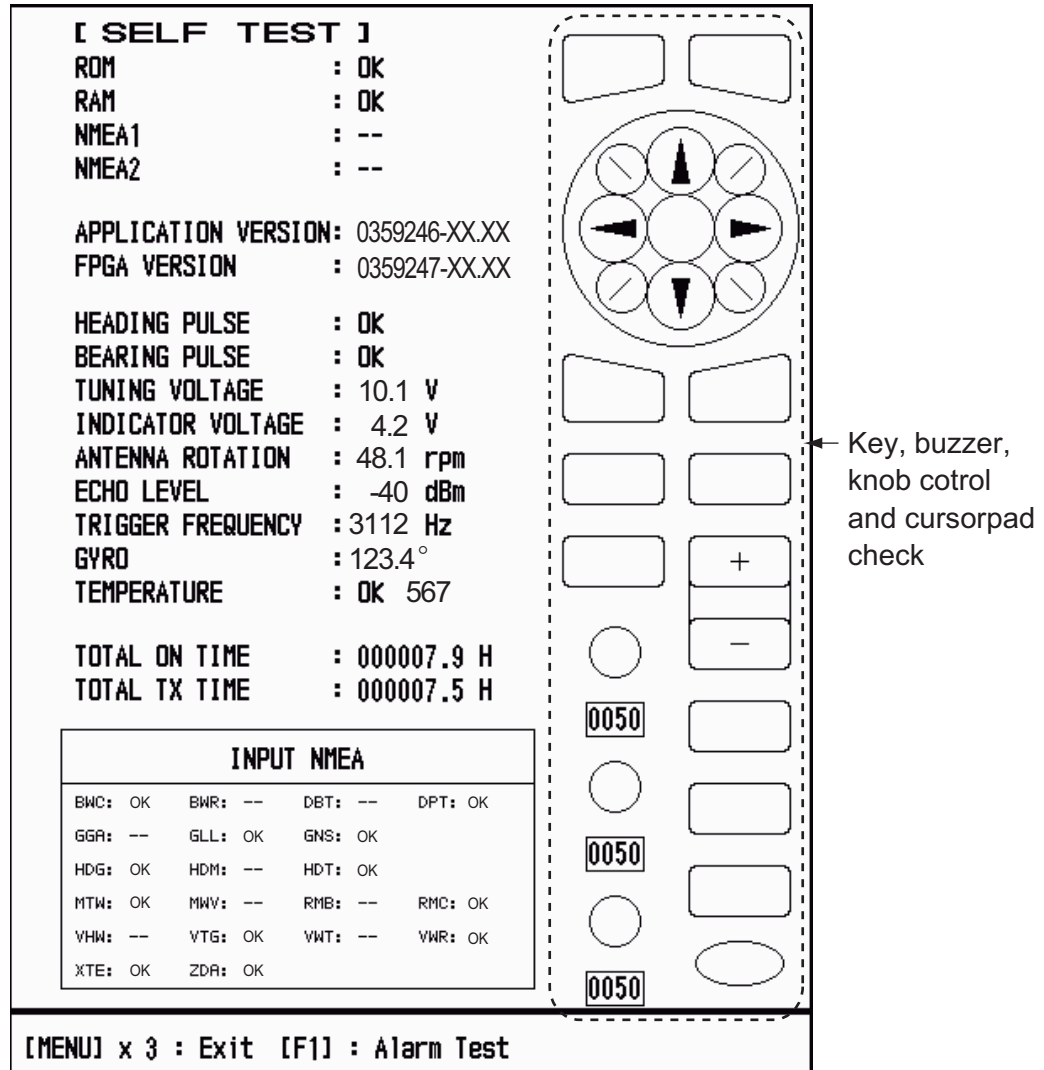

XX: Program version no.

Self Test screen

Test results

- ROM, RAM: The results of the ROM and RAM test are displayed as OK or NG (No Good).
- NMEA1, NMEA2: The results of the ports NMEA1 and NMEA2 are displayed as OK or "-". Ports NMEA1 and NMEA2 require a special connector to test them. When a special connector is not connected, "-" is shown. If "-" is displayed with a special connector, contact your dealer for instruction.
- APPLICATION VERSION, FPGA VERSION: The program numbers and program version numbers (XX) are displayed.

6. MAINTENANCE, TROUBLESHOOTING

- **HEADING PULSE, BEARING PULSE:** The results of the pulse input are displayed as OK or NG. When [Antenna Rotation] is set to [Stop], or [Watchman] is set to [Off] in the STBY mode, this test is skipped and "- -" is shown for both heading and bearing.
- **TUNING VOLTAGE, INDICATOR VOLTAGE, ANTENNA ROTATION, ECHO LEVEL, TRIGGER FREQUENCY:** The results of measurement are displayed.
- **GYRO:** The current gyrocompass reading is displayed.
- **TEMPERATURE:** The result of the temperature test is displayed as OK or NG and the temperature is measured and shown.
- **TOTAL ON TIME, TOTAL TX TIME:** The total number of hours, for which the radar has been powered and transmitted, are displayed.
- **INPUT NMEA window:** The condition of all the NMEA sentences being input to this radar are displayed as OK or "- -". "- -" means no data input. Sentences are updated every second.

Key check

Press each key one by one. A key's on-screen location becomes green if the key is normal.

Buzzer check

The **F1** key tests on/off for the panel buzzer or external buzzer. To stop the buzzer, press the **F1** key again.

Knob control check

Rotate each control knob. The four digits below the on-screen location for the **GAIN**, **A/C SEA** and **A/C RAIN** knob controls show the control position. Press each knob. The knob corresponding on-screen circle changes in green if the knob is normal.

Cursorpad check

Press each arrow and diagonal dot one by one. The on-screen location changes in green if the key is normal.

4. Press the **MENU** key three times to escape from the test.
5. Press the **MENU** key to close the menu.

6.7 LCD Test

1. Press the **MENU** key to open the menu.
2. Use the Cursorpad (▲ or ▼) to select [Tests] and press the **ENTER** key.
3. Use the Cursorpad (▲ or ▼) to select [LCD Pattern] and press the **ENTER** key.

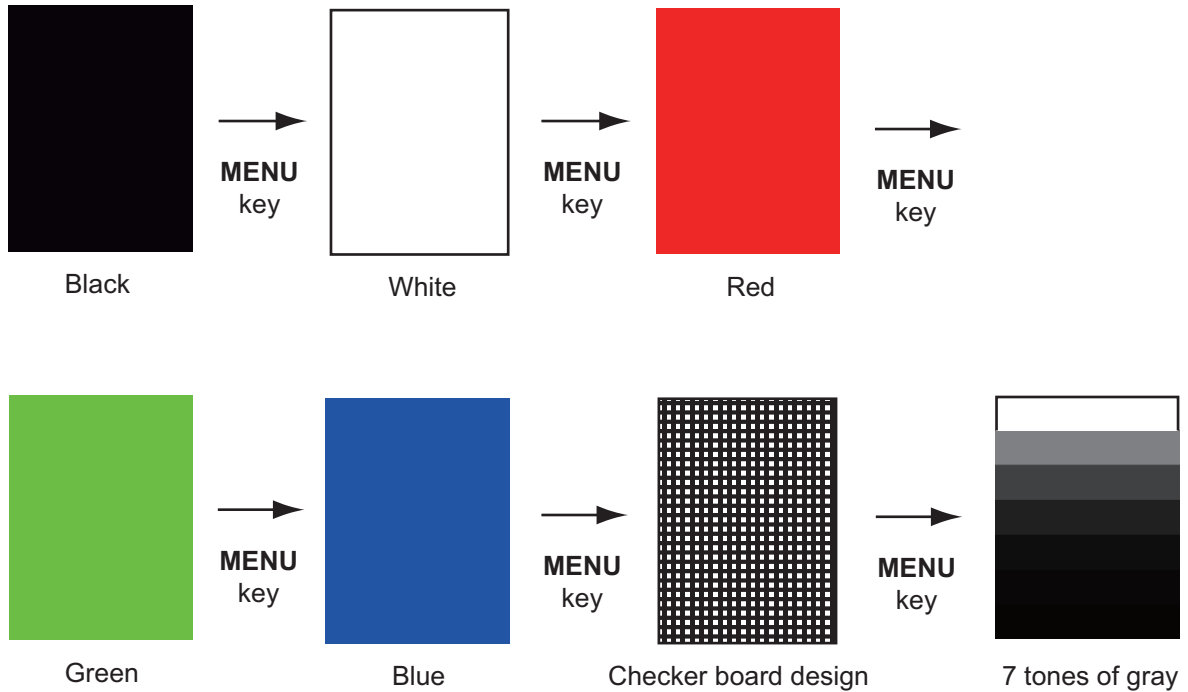

4. Press the **MENU** key several times to close the menu.

Note 1: You can cancel the test at any time when you press the **CANCEL/HL OFF** key.

Note 2: You can adjust the screen brilliance with the  key during the test.

6.8 ARPA Test

If the optional ARPA board is installed, its program number and test results (OK or NG) are shown on the screen. [ARPA Test] menu item is inoperative with no ARPA board. The radar must be transmitting to test ARPA function.

1. Press the **MENU** key to open the menu.
2. Use the Cursorpad (▲ or ▼) to select [Tests] and press the **ENTER** key.
3. Use the Cursorpad (▲ or ▼) to select [ARPA Test] and press the **ENTER** key.

[ARPA TEST]			
ROM	:	OK	
RAM	:	OK	
ARPA VERSION	:	1859127XXX	
SPEED	:	OK	12.3KN
COURSE	:	OK	287.6°
TRIGGER	:	OK	
VIDEO	:	OK	
BEARING PULSE	:	OK	
HEADING PULSE	:	OK	
MIN-HIT	:	0012	
SCAN-TIME	:	0250	
MANUAL-ACQ	:	03	
AUTO-ACQ	:	05	
FE-DATA1	:	0217	
FE-DATA2	:	0023	
ECHO NUMBER			
[No. 1]	0123	[No. 2]	0321
[No. 3]	0084	[No. 4]	0234
[No. 5]	0110	[No. 6]	0219
[No. 7]	0073	[No. 8]	0145
[MENU] x 3 : Exit			

XXX: Program version no.

ARPA test

4. Press the **MENU** key three times to close the menu.

6.9 GPS Test

You can check the FURUNO GPS receiver GP-320B interfaced with this radar for correct operation as follows:

1. Press the **MENU** key to open the menu.
2. Use the Cursorpad (▲ or ▼) to select [GPS] and press the **ENTER** key.
3. Use the Cursorpad (▲ or ▼) to select [Self Test] and press the **ENTER** key. The program no. and result of the test are shown, as OK or NG (No Good). When NG appears, check the GPS receiver.

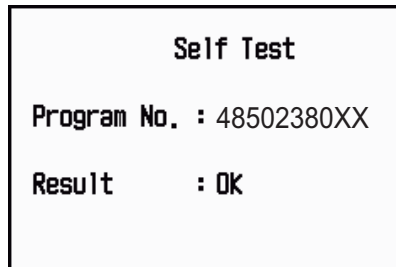

XX: Program version no. varies according to equipment connected.

GPS-Self Test screen

4. Press any key to close the test screen.
5. Press the **MENU** key to close the menu.

6. MAINTENANCE, TROUBLESHOOTING

This page is intentionally left blank.

APPENDIX 1 MENU TREE

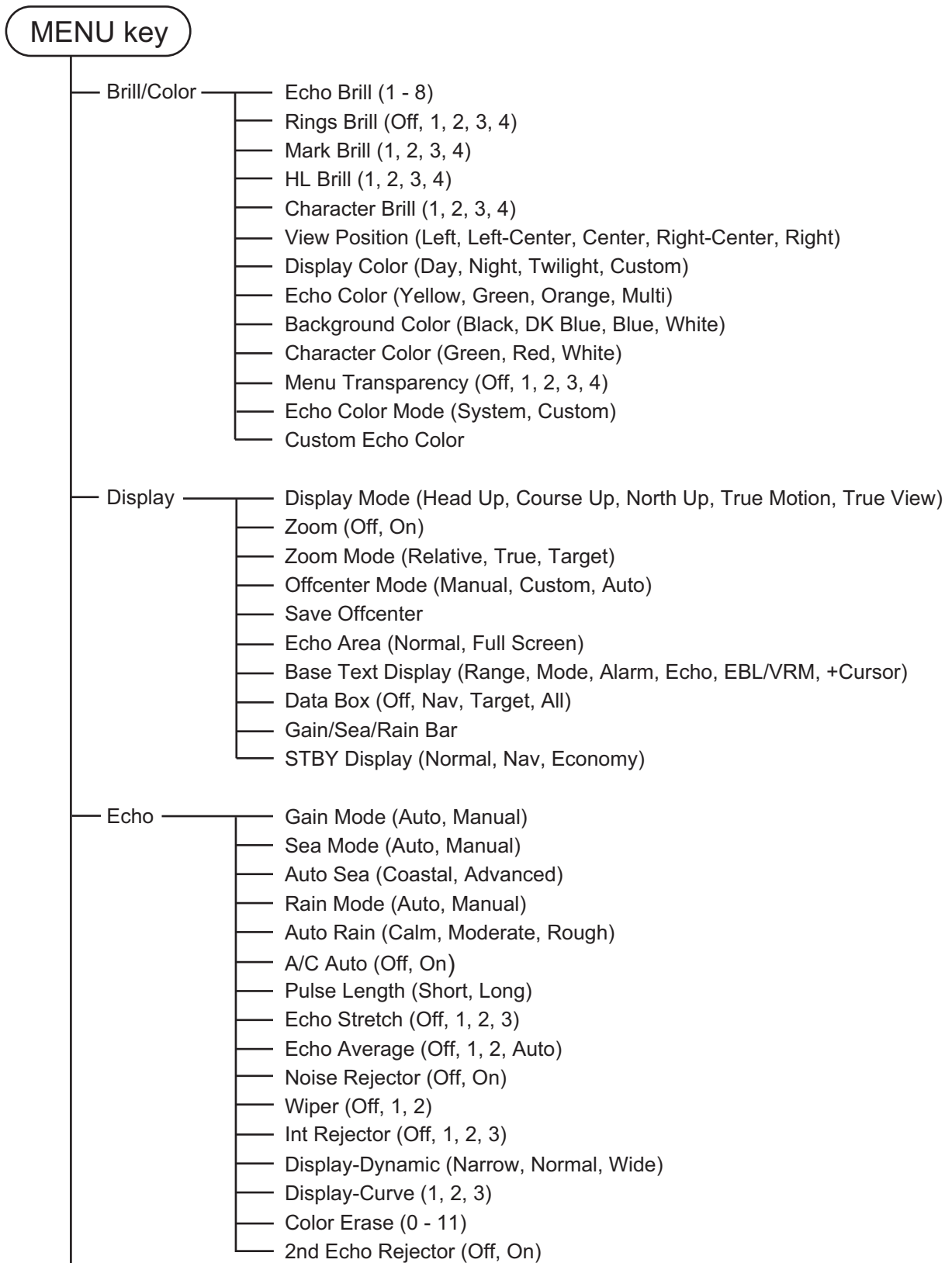

(Continued on next Page)

APPENDIX 1 MENU TREE

(Continued from previous page)

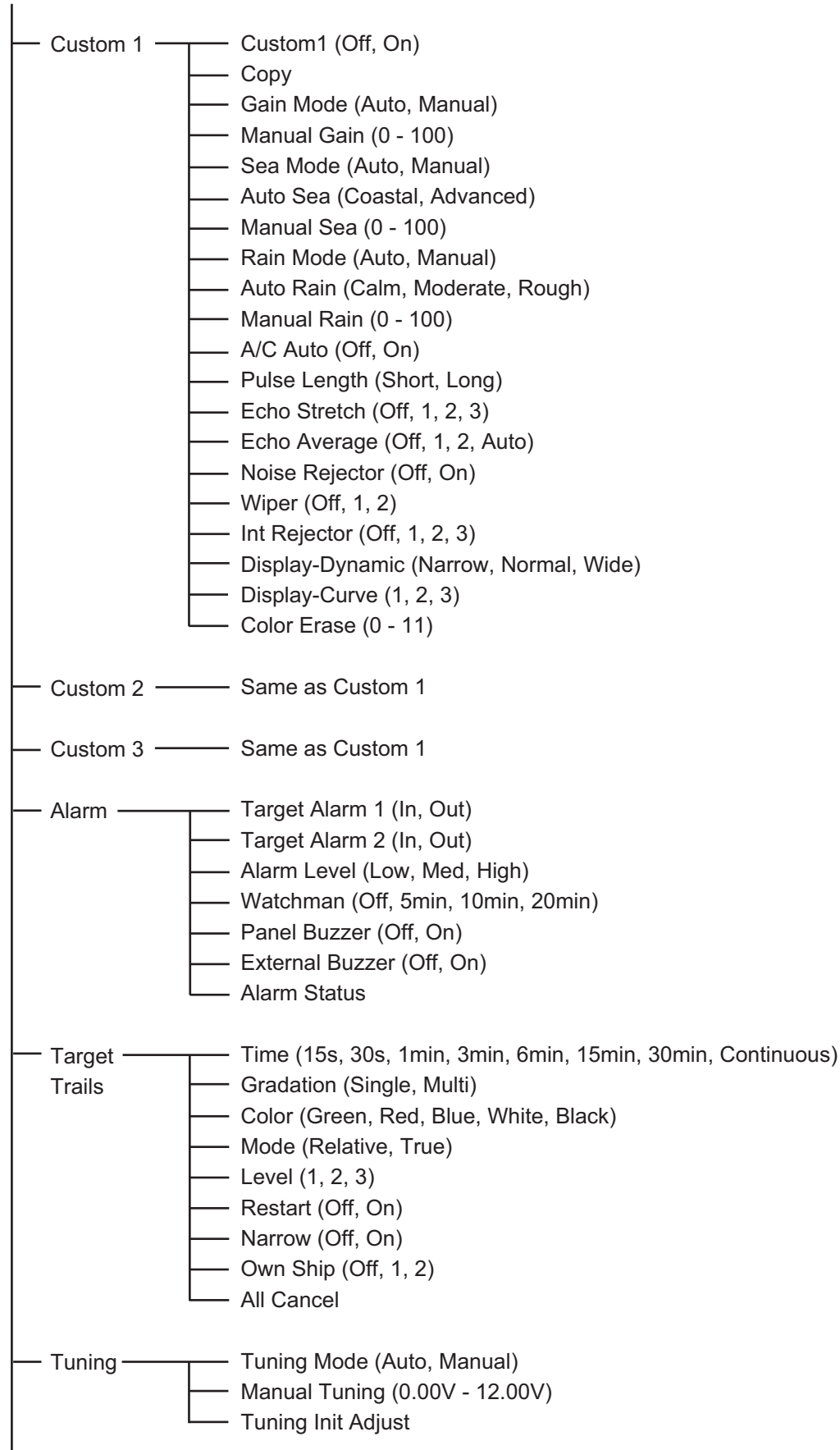

(Continued on next page)

(Continued from previous page)

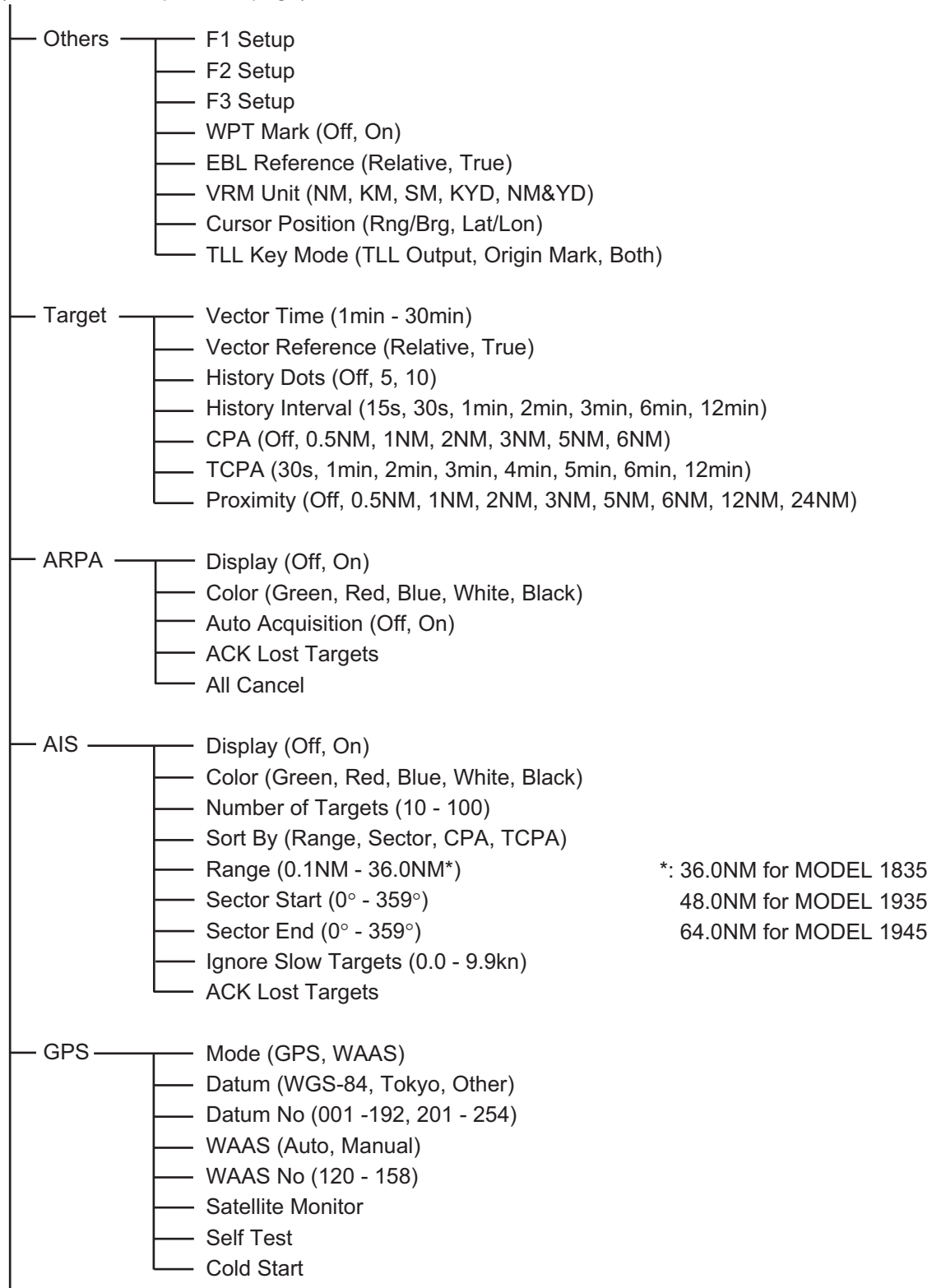

(Continued on next page)

APPENDIX 1 MENU TREE

(Continued from previous page)

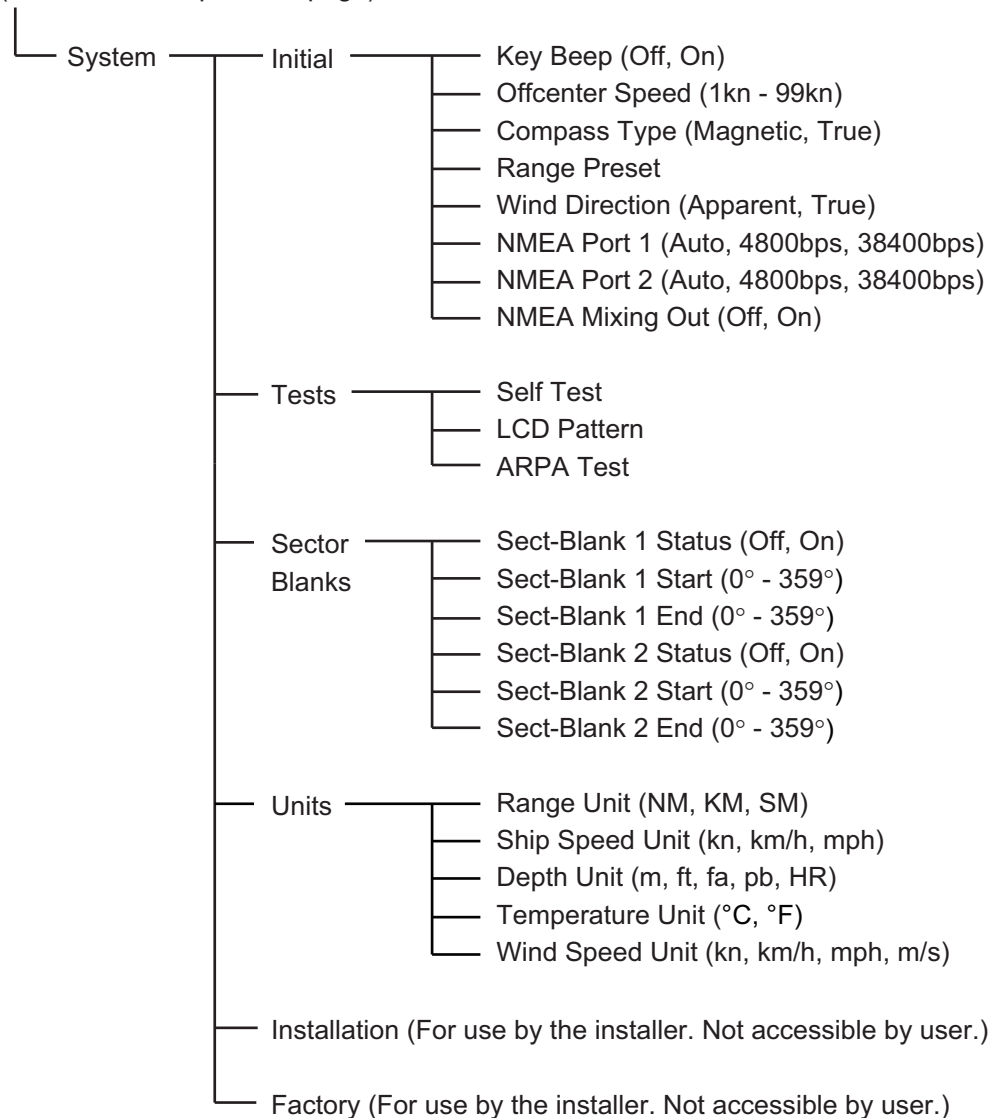

APPENDIX 2 GEODETIC CHART LIST

001: WGS84		
002: WGS72		
003: TOKYO		
004: NORTH AMERICAN 1927	: Mean Value (Japan, Korea & Okinawa)	
005: EUROPEAN 1950	: Mean Value (CONUS)	
006: AUSTRALIAN GEODETIC 1984	: Mean Value	
007: ADINDAN-MN	: Australia & Tasmania	
008: ADINDAN-E	: Mean Value (Ethiopia & Sudan)	
009: ADINDAN-MA	: Ethiopia	
010: ADINDAN-SE	: Mali	
011: ADINDAN-SU	: Senegal	
012: AFG	: Sudan	
013: AIN EL ABD 1970	: Somalia	
014: ANNA 1 ASTRO 1965	: Bahrain Is.	
015: ARC 1950-MN	: Cocos Is.	
016: ARC 1950-B	: Mean Value	
017: ARC 1950-L	: Botswana	
018: ARC 1950-M	: Lesotho	
019: ARC 1950-S	: Malawi	
020: ARC 1950-ZR	: Swaziland	
021: ARC 1950-ZM	: Zaire	
022: ARC 1950-ZB	: Zambia	
023: ARC 1960-MN	: Zimbabwe	
024: ARC 1960-K	: Mean Value (Kenya & Tanzania)	
025: ARC 1960-T	: Kenya	
026: ASCENSION IS. 1958	: Tanzania	
027: ASTRO BEACON "E"	: Ascension Is.	
028: ASTRO B4 SOR. ATOLL	: Iwo Jima Is.	
029: ASTRO POS 71/4	: Tern Is.	
030: ASTRONOMIC STATION 1952	: St. Helena Is.	
031: AUSTRALIAN GEODETIC 1966	: Marcus Is.	
032: BELLEVUE (IGN)	: Australia & Tasmania	
033: BERMUDA 1957	: Efate & Erromango Is.	
034: BOGOTA OBSERVATORY	: Bermuda Is.	
035: CAMPO INCHAUSPE	: Columbia	
036: CANTON IS. 1966	: Argentina	
037: CAPE	: Phoenix Is.	
038: CAPE CANAVERAL	: South Africa	
039: CARTHAGE	: Mean Value (Florida & Bahama Is.)	
040: CHATHAM 1971	: Tunisia	
041: CHUA ASTRO	: Chatham Is. (New Zealand)	
042: CORREGO ALEGRE	: Paraguay	
043: DJAKARTA (BATAVIA)	: Brazil	
044: DOS 1968	: Sumatra Is. (Indonesia)	
045: EASTER IS. 1967	: Gizo Is. (New Georgia Is.)	
046: EUROPEAN 1950-W	: Easter Is.	
047: EUROPEAN 1950-CY	: Western Europe	
048: EUROPEAN 1950-EG	: Cyprus	
049: EUROPEAN 1950-ESC	: Egypt	
050: EUROPEAN 1950-EIS	: England, Scotland, Channel & Shetland Is.	
051: EUROPEAN 1950-GR	: England, Ireland, Scotland & Shetland Is.	
052: EUROPEAN 1950-IR	: Greece	
053: EUROPEAN 1950-SA	: Iran	
054: EUROPEAN 1950-SI	: Italy, Sardinia	
055: EUROPEAN 1950-NF	: Italy, Sicily	
056: EUROPEAN 1950-PS	: Norway & Finland	
057: EUROPEAN 1979	: Portugal & Spain	
058: GANDAJIKA BASE	: Mean Value	
059: GEODETIC DATUM 1949	: Republic of Maldives	
060: GUAM 1963	: New Zealand	
061: GUX 1 ASTRO	: Guam Is.	
062: HJORSEY 1955	: Guadalcanal Is.	
063: HONG KONG 1963	: Iceland	
064: INDIAN-TV	: Hong Kong	
065: INDIAN-BIN	: Thailand & Vietnam	
066: IRELAND 1965	: Bangladesh, India & Nepal	
067: ISTS 073 ASTRO 1969	: Ireland	
068: JOHNSTON IS. 1961	: Diego Garcia	
069: KANDAWALA	: Johnston Is.	
070: KERGUELEN IS.	: Sri Lanka	
071: KERTAU 1948	: Kerguelen Is.	
072: LA REUNION	: West Malaysia & Singapore	
073: L. C. 5 ASTRO	: Mascarene Is.	
074: LIBERIA 1964	: Cayman Brac Is.	
075: LUZON	: Liberia	
076: LUZON-M	: Philippines (excl. Mindanao Is.)	
077: MAHE 1971	: Mindanao Is.	
078: MARCO ASTRO	: Mahe Is.	
079: MASSAWA	: Salvage Islands	
080: MERCHICH	: Eritrea (Ethiopia)	
081: MIDWAY ASTRO 1961	: Morocco	
082: MINNA	: Midway Is.	
083: NAHRWAN-O	: Nigeria	
084: NAHRWAN-UAE	: Masirah Is. (Oman)	
085: NAHRWAN-SA	: United Arab Emirates	
086: NAMIBIA	: Saudi Arabia	
087: MAPARIMA, BWI	: Namibia	
088: NORTH AMERICAN 1927WU	: Trinidad & Tobago	
089: NORTH AMERICAN 1927EU	: Western United States	
090: NORTH AMERICAN 1927AK	: Eastern United States	
	: Alaska	
091: NORTH AMERICAN 1927BH	: Bahamas (excl. San Salvador Is.)	
092: NORTH AMERICAN 1927SS	: Bahamas, San Salvador Is.	
093: NORTH AMERICAN 1927CN	: Canada (incl. Newfoundland Is.)	
094: NORTH AMERICAN 1927AB	: Alberta & British Columbia	
095: NORTH AMERICAN 1927EC	: East Canada	
096: NORTH AMERICAN 1927MO	: Manitoba & Ontario	
097: NORTH AMERICAN 1927NE	: Northwest Territories & Saskatchewan	
098: NORTH AMERICAN 1927YK	: Yukon	
099: NORTH AMERICAN 1927CZ	: Canal Zone	
100: NORTH AMERICAN 1927CR	: Caribbean	
101: NORTH AMERICAN 1927CA	: Central America	
102: NORTH AMERICAN 1927CU	: Cuba	
103: NORTH AMERICAN 1927GR	: Greenland	
104: NORTH AMERICAN 1927MX	: Mexico	
105: NORTH AMERICAN 1983AK	: Alaska	
106: NORTH AMERICAN 1983CN	: Canada	
107: NORTH AMERICAN 1983CS	: CONUS	
108: NORTH AMERICAN 1983MX	: Mexico, Central America	
109: OBSERVATORIO 1966	: Corvo & Flores Is. (Azores)	
110: OLD EGYPTIAN 1930	: Egypt	
111: OLD HAWAIIAN-MN	: Mean Value	
112: OLD HAWAIIAN-HW	: Hawaii	
113: OLD HAWAIIAN-KA	: Kauai	
114: OLD HAWAIIAN-MA	: Maui	
115: OLD HAWAIIAN-OA	: Oahu	
116: OMAN	: Oman	
117: ORDNANCE SURVEY OF GREAT BRITAIN 1936-NM	: Mean Value	
118: ORDNANCE SURVEY OF GREAT BRITAIN 1936-E	: England	
119: ORDNANCE SURVEY OF GREAT BRITAIN 1936-IM	: England, Isle of Man & Wales	
	: Scotland & Shetland Is.	
120: ORDNANCE SURVEY OF GREAT BRITAIN 1936-SSI	: Shetland Is.	
	: Wales	
121: ORDNANCE SURVEY OF GREAT BRITAIN 1936-WL	: Wales	
122: PICO DE LAS NIVIES	: Canary Is.	
123: PITCAIRN ASTRO 1967	: Pitcairn Is.	
124: PROVISIONS SOUTH CHILEAN 1963: South Chile (near 53°S)		
125: PROVISIONAL SOUTH AMERICAN 1956MN: Mean Value		
126: PROVISIONAL SOUTH AMERICAN 1956BO: Bolivia		
127: PROVISIONAL SOUTH AMERICAN 1956NC: Chile-Northern Chile (near 19°S)		
	: Chile-Southern Chile (near 43°S)	
128: PROVISIONAL SOUTH AMERICAN 1956SC: Chile-Southern Chile (near 43°S)		
129: PROVISIONAL SOUTH AMERICAN 1956CO: Columbia		
130: PROVISIONAL SOUTH AMERICAN 1956EC: Ecuador		
131: PROVISIONAL SOUTH AMERICAN 1956GY: Guyana		
132: PROVISIONAL SOUTH AMERICAN 1956PR: Peru		
133: PROVISIONAL SOUTH AMERICAN 1956VN: Venezuela		
134: PUERTO RICO	: Puerto Rico & Virgin Is.	
135: QATAR NATIONAL	: Qatar	
136: QORNOQ	: South Greenland	
137: ROME 1940	: Sardinia Is.	
138: SANTA BRAZ	: Sao Miguel, Santa Maria Is. (Azores)	
139: SANTO (DOS)	: Espiritu Santo Is.	
140: SAPPER HILL 1943	: East Falkland Is.	
141: SOUTH AMERICAN 1969MN	: Mean Value	
142: SOUTH AMERICAN 1969AG	: Argentina	
143: SOUTH AMERICAN 1969BO	: Bolivia	
144: SOUTH AMERICAN 1969BR	: Brazil	
145: SOUTH AMERICAN 1969CH	: Chile	
146: SOUTH AMERICAN 1969CO	: Columbia	
147: SOUTH AMERICAN 1969EC	: Ecuador	
148: SOUTH AMERICAN 1969GY	: Guyana	
149: SOUTH AMERICAN 1969PA	: Paraguay	
150: SOUTH AMERICAN 1969PR	: Peru	
151: SOUTH AMERICAN 1969TT	: Trinidad & Tobago	
152: SOUTH AMERICAN 1969VZ	: Venezuela	
153: SOUTH ASIA	: Singapore	
154: SOUTHEAST BASE	: Porto Santo & Madeira Is.	
155: SOUTHWEST BASE	: Faial, Graciosa, Pico, Sao Jorge & Terceira Is.	
156: TIMBALAI 1948	: Brunei & East Malaysia (Sarawak & Sabah)	
157: TOKYO JP	: Japan	
158: TOKYO KP	: Korea	
159: TOKYO OK	: Okinawa	
160: TRISTAN ASTRO 1968	: Tristan da Cunha	
161: VITI LEVU 1916	: Viti Levu Is. (Fiji Is.)	
162: WAKE-ENIWETOK 1960	: Marshall Is.	
163: ZANDERIJ	: Surinam	
164: BUKIT RIMPAH	: Bangka & Belitung Is. (Indonesia)	
165: CAMP AREA ASTRO	: Camp Marmora Area, Antarctica	
166: G. SEGARA	: Kalimantan Is. (Indonesia)	
167: HERAT NORTH	: Afghanistan	
168: HU-TZU-SHAN	: Taiwan	
169: TANANARIVE OBSERVATORY 1925	: Madagascar	
170: YACARE	: Uruguay	
171: RT-90	: Sweden	
172: TOKYO	: Mean Value (Japan, Korea & Okinawa)	
173: AIN EL ABD 1970	: Bahrain Is.	
174: ARC 1960	: Mean Value (Kenya, Tanzania)	
175: ARS-A	: Kenya	

APPENDIX 2 GEODETIC CHART LIST

176: ARS-B	: Tanzania	221: INDIAN 1960	: Con Son Is. (Vietnam)
177: ASCENSION IS. 1958	: Ascension Is.	222: INDIAN 1975	: Thailand
178: CAPE CANAVERAL	: Mean Value (Florida & Bahama Is.)	223: INDONESIAN 1974	: Indonesia
179: EASTER IS. 1967	: Easter Is.	224: CO-ORDINATE SYSTEM 1937 OF ESTONIA	: Estonia
180: EUROPEAN 1950	: Portugal & Spain	225: EUROPEAN 1950	: Malta
181: JHONSTON IS. 1961	: Jhonston Is.	226: EUROPEAN 1950	: Tunisia
182: NAHRWAN	: Saudi Arabia	227: S-42 (PULKOVO 1942)	: Hungary
183: NAPARIMA, BWI	: Trinidad & Tobago	228: S-42 (PULKOVO 1942)	: Poland
184: NORTH AMERICAN 1927	: Caribbean	229: S-42 (PULKOVO 1942)	: Czechoslovakia
185: OLD HAWAIIAN	: Oahu	230: S-42 (PULKOVO 1942)	: Latvia
186: SAPPER HILL 1943	: East Falkland Is.	231: S-42 (PULKOVO 1942)	: Kazakhstan
187: TIMBALAI 1948	: Brunei & East Malaysia (Sarawak & Sabah)	232: S-42 (PULKOVO 1942)	: Albania
188: TOKYO	: Japan	233: S-42 (PULKOVO 1942)	: Romania
189: TOKYO	: South Korea	234: S-JTSK	: Czechoslovakia
190: TOKYO	: Okinawa	235: NORTH AMERICAN 1927	: East of 180W
191: WAKE-ENIWETOK 1960	: Marshall Is.	236: NORTH AMERICAN 1927	: West of 180W
192: HU-TZU-SHAN	: Taiwan	237: NORTH AMERICAN 1983	: Aleutian Is.
201: ADINDAN	: Burkina Faso	238: NORTH AMERICAN 1983	: Hawaii
202: ADINDAN	: Cameroon	239: SOUTH AMERICAN 1969	: Baltra, Galapagos Is.
203: ARC 1950	: Burundi	240: ANTIGUA IS. ASTRO 1943	: Antigua, Leeward Is.
204: AYABELLE LIGHTHOUSE	: Djibouti	241: DECEPTION IS.	: Deception Is., Antarctica
205: BISSAU	: Guinea-Bissau	242: FORT THOMAS 1955	: Nevis, St. Kitts, Leeward Is.
206: DABOLA	: Guinea	243: ISTS 061 ASTRO 1968	: South Georgia Is.
207: EUROPEAN 1950	: Tunisia	244: MONTSERRAT IS. ASTRO 1958	: Montserrat, Leeward Is.
208: LEIGON	: Ghana	245: FEUNION	: Mascarene Is.
209: MINNA	: Cameroon	246: AMERICAN SAMOA 1962	: American Samoa Is.
210: M' PORALOKO	: Gabon	247: INDONESIAN 1974	: Indonesia
211: NORTH SAHARA 1959	: Algeria	248: KUSAIE ASTRO 1951	: Caroline Is., Fed. States of Micronesia
212: POINT58	: Mean Solution (Burkina Faso & Niger)	249: WAKE Is. ASTRO 1952	: Wake Atoll
213: POINTE NOIRE 1948	: Congo	250: EUROPEAN 1950	: Iraq, Israel, Jordan, Kuwait, Lebanon, Saudi Arabia, and Syria
214: SIERRA LEONE 1960	: Sierra Leone	251: HERMANNSKOGEL	: Yugoslavia (Prior to 1990) Slovenia, Croatia Bosnia and Herzegovina Serbia
215: VOIROL 1960	: Algeria	252: INDIAN	: Pakistan
216: AIN EL ABD 1970	: Saudi Arabia	253: PULKOVO 1942	: Russia
217: INDIAN	: Bangladesh	254: VOIROL 1874	: Tunisia/Algeria
218: INDIAN	: India & Nepal		
219: INDIAN 1954	: Thailand		
220: INDIAN 1960	: Vietnam (near 16N)		

SPECIFICATIONS OF MARINE RADAR MODEL 1835 series

1 GENERAL

1.1 Range scale, pulselength (PL) and Pulse repetition rate (PRR)

MODEL 1835

Range scale (NM)	PL (μ s)	PRR (Hz approx.)
0.0625 to 1.5	0.08	2100
1.5 to 3	0.3	1200
3 to 36	0.8	600

MODEL 1935

Range scale (NM)	PL (μ s)	PRR (Hz approx.)
0.0625 to 1.5	0.08	2100
1.5 to 3	0.3	1200
3 to 48	0.8	600

MODEL 1945

Range scale (NM)	PL (μ s)	PRR (Hz approx.)
0.0625 to 1.5	0.08	2100
1.5 to 3	0.3	1200
3 to 64	0.8	600

- 1.2 Range discrimination 25 m
- 1.3 Minimum range 25 m
- 1.4 Bearing resolution MODEL 1835: 4°, MODEL 1935: 2.4°, MODEL 1945: 1.9°
- 1.5 Bearing accuracy $\pm 1^\circ$
- 1.6 Range ring accuracy 0.9% of range in use or 8 m, whichever is greater

2 ANTENNA UNIT

- 2.1 Radiator type
 - MODEL 1835 Printed array
 - MODEL 1935/ MODEL 1945 Slotted waveguide array
- 2.2 Radiator length
 - MODEL 1835 60 cm
 - MODEL 1935 100 cm
 - MODEL 1945 120 cm
- 2.3 Horizontal beamwidth
 - MODEL 1835 4.0°
 - MODEL 1935 2.4°
 - MODEL 1945 1.9°
- 2.4 Vertical beamwidth
 - MODEL 1835 20°
 - MODEL 1935/ MODEL 1945 22°
- 2.5 Sidelobe
 - MODEL 1835 Within $\pm 20^\circ$ of main lobe: -18dB, outside $\pm 20^\circ$ of main lobe: -23dB
 - MODEL 1935 Within $\pm 20^\circ$ of main lobe: -20dB, outside $\pm 20^\circ$ of main lobe: -28dB
 - MODEL 1945 Within $\pm 20^\circ$ of main lobe: -24dB, outside $\pm 20^\circ$ of main lobe: -30dB
- 2.6 Polarization Horizontal
- 2.7 Antenna rotation speed

- MODEL 1835 24 rpm
- MODEL 1935/ MODEL 1945 24 rpm/48 rpm
- 2.8 Wind resistance (MODEL 1935 and MODEL 1945)
Relative wind speed 100 kn for 24 rpm/ 70 kn for 48 rpm

3 TRANSCEIVER MODULE (CONTAINED IN ANTENNA UNIT)

- 3.1 Radiation type P0N
- 3.2 Frequency 9410 MHz±30MHz
- 3.3 Peak output power
MODEL 1835/ MODEL 1935 4 kW
MODEL 1945 6 kW
- 3.4 Duplexer Circulator with diode limiter
- 3.5 Modulator switching FET
- 3.6 IF amplifier Log-amplifier
- 3.7 IF frequency 60 MHz
- 3.8 Tuning Automatic or manual
- 3.9 Warm-up time 90 s

4 DISPLAY UNIT

- 4.1 Screen type 10.4-inch color LCD, 640 (V) x 480 (H) dots, VGA
- 4.2 Effective radar diameter 158 mm
- 4.3 Range scales and Ring interval

Range scale (NM)	0.0625	0.125	0.25	0.5	0.75	1	1.5	1.6	2	3	3.2	4	6	8	12
Ring interval (NM)	0.03125	0.0625	0.125	0.125	0.25	0.25	0.5	0.4	0.5	1	0.8	1	2	2	3
Number of rings	2	2	2	4	3	4	3	4	4	3	4	4	3	4	4

16	24	32	36	48*	64**
4	6	8	12	12*	16**
4	4	4	3	4*	4**

*: for MODEL 1935 and MODEL 1945, **: for MODEL 1945

- 4.4 Marks Heading line, Bearing scale, Range ring, Tuning indicator, Cursor, North mark, Variable range marker (VRM), Electric bearing line (EBL), Target alarm zone, Zoom window, Waypoint mark*, Origin mark*
- 4.5 Alphanumeric indication Range, Range ring interval, Pulselength (SP/MP/LP), Display mode (H UP/C UP/N UP/TM/TRUE VIEW), Off-centre (OFFCENT (M/A/C)), Heading data*, Target trails, Tuning indicator, Target alarms, Echo stretch (ES), Echo average (EAV), Electric bearing line (EBL), Vector time*, Range and bearing to cursor or cursor position*, Interference rejecter (IR), Auto anti-clutter (A/C Auto), Variable range marker (VRM), Navigation data*(position, speed, course), ARPA/AIS target data*

*: external data required

5 INTERFACE

- 5.1 Heading signal AD-10 format or NMEA0183
- 5.2 NMEA 2 ports, NMEA0183 Ver-1.5/2.0/3.0
- 5.3 Remote display/ Ext. buzzer 1 port (option)
- 5.4 USB 1 port, USB2.0 for maintenance
- 5.5 Input data sentences ALR, BWC, BWR, DBT, DPT, DTM, GGA, GLL, GNS, GSA, GSV, HDG, HDT, HDM, MTW, MWV, RMB, RMC, TTM*, VDM, VHW, VTG, VWR, VWT, XTE, ZDA
*: data from radiotelephone only
- 5.6 Output data sentences RSD, TLL, TTM (requires ARP-11)

6 POWER SUPPLY

- 6.1 MODEL 1835 12-24 VDC: 4.1-2.0 A
- 6.2 MODEL 1935 12-24 VDC: 6.8-3.3 A for 24 rpm, 8.2-3.8 A for 48 rpm
- 6.3 MODEL 1945 12-24 VDC: 7.3-3.5 A for 24 rpm, 8.8-4.1 A for 48 rpm
- 6.4 Rectifier (option)
PR-62 (MODEL 1835) 100/110/220/230 VAC, 1 phase, 50/60 Hz
RU-3423 (MODEL 1935 and MODEL 1945)
100/110/115/220/230 VAC, 1 phase, 50/60 Hz

7 ENVIRONMENTAL CONDITION

- 7.1 Ambient temperature
 - Antenna unit -25°C to +55°C
 - Display unit -15°C to +55°C
- 7.2 Relative humidity 93% at 40°C
- 7.3 Degree of protection
 - Antenna unit IP26
 - Display unit IP55
- 7.4 Vibration IEC 60945

8 COATING COLOR

- 8.1 Antenna unit N9.5
- 8.2 Display unit N2.5

9 COMPASS SAFE DISTANCE

- 9.1 Antenna unit
 - MODEL 1835 Standard: 0.90 m, Steering: 0.70 m
 - MODEL 1935/ MODEL 1945 Standard: 1.00 m, Steering: 0.75 m
- 9.2 Display unit Standard: 0.45 m, Steering: 0.30 m

This page is intentionally left blank.

INDEX

A

A/C RAIN control	1-12
A/C SEA control	1-11
AIS	
activating targets	4-2
controls for	4-1
display on/off	4-1
display range	4-4
sleeping targets	4-2
sorting targets	4-4
symbols	4-2
target data	4-3
Alarm message	1-46
Anti-clutter	1-13

ARPA

acquiring targets	3-2
controls for	3-1
CPA/TCPA alarm	3-8, 4-8
display on/off	3-2
display sector	4-5
history display	3-6, 4-7
lost target	3-10, 4-9
number of targets	4-5
precautions for use	3-1
proximity alarm	3-9, 4-9
stopping tracking of targets	3-3
symbol color	3-10, 4-10
target data	3-7
test	6-10
vector	3-4, 4-6

B

Background color	1-42
Brilliance	1-35

C

CANCEL/HL OFF key	1-35
Characteristics curve	1-45
Color selections	1-41
Controls	1-1
Course-up mode	1-8
CPA/TCPA alarm	
AIS	4-8
ARPA	3-8
Cursor	1-14
CUSTOM key	1-36
Custom setup	
description	1-36
setting	1-37

D

Depth unit	1-51
Display indications	1-3
Display mode	
course-up	1-8

head-up	1-8
north-up	1-8
true motion	1-9
true view	1-9
Dynamic range	1-44

E

EBL	
measuring bearing by	1-18
reference	1-19
EBL key	1-18
Echo area	1-48
Echo average	1-29
Echo stretch	1-29

F

F1, F2, F3 key	1-38
False echoes	2-3
Function keys	1-38
Fuse replacement	6-2

G

GAIN control	1-10
GPS	
cold start	5-4
datum	5-1
navigator mode	5-1
satellite monitor	5-3
test	6-11
WAAS	5-2

H

Heading line	1-35
Head-up mode	1-8
History display	
AIS	4-7
ARPA	3-6

I

Initial sub menu	1-49
Interference rejector	1-15

L

Lost target	
AIS	4-9
ARPA	3-10

M

Magnetron life	6-3
Maintenance	
fuse replacement	6-2
magnetron life	6-3
preventive	6-2
Menu	1-4
MENU key	1-4
Multiple echoes	2-3

INDEX

N

Navigation data	
at screen bottom	1-43
stand-by	1-43
Noise rejector	1-39
North-up mode	1-8

O

OFF CENTER key	1-25
Off-centering the display	1-25

P

POWER/BRILL key	1-2, 1-4
Proximity alarm	
AIS	4-9
ARPA	3-9
Pulselength	1-20

Q

Quick start	1-2
-------------------	-----

R

RACON	2-8
Range and bearing between two targets .	1-19
RANGE key	1-9
Range measurement	1-16
Range preset	1-49
Range ring brilliance	1-16
Range unit	1-51
Remote display	1-56

S

SART	2-6
Second-trace echoes	1-40
Sector blank	1-52
Shadow sector	2-5
Ship speed unit	1-51
Sidelobe echoes	2-4
STBY/TX key	1-2
System configuration	xii

T

Target alarm	
alarm type	1-23
deactivating	1-23, 1-24
setting	1-22
stopping	1-22
strength level	1-24
TARGET ALARM key	1-22
Target trails	
color	1-32
gradation	1-32
level	1-33
mode	1-31
narrow trails	1-34
restarting	1-33
starting	1-31
stopping	1-31
trail copy	1-33
your ship trail	1-34
Temperature unit	1-51

Test

ARPA	6-10
diagnostic	6-7
GPS	6-11
LCD	6-9
TLL key	1-34
TRAILS key	1-31
Troubleshooting	
advanced-level	6-5
simple	6-4
True motion mode	1-9
True view mode	1-9
Tuning	1-6

V

Virtual image	2-4
VRM	
measuring range by	1-17
unit of range measurement	1-17
VRM key	1-17

W

Watchman	1-40
Waypoint marker	1-46
Wind direction	1-51
Wind speed unit	1-51
Wiper	1-39

Z

Zoom	1-27
------------	------

Declaration of Conformity



We **FURUNO ELECTRIC CO., LTD.**

(Manufacturer)

9-52 Ashihara-Cho, Nishinomiya City, 662-8580, Hyogo, Japan

(Address)

declare under our sole responsibility that the product

MARINE RADAR MODEL 1835, MODEL 1935, MODEL 1937 and MODEL 1945

(Model name, type number)

are in conformity with the essential requirements as described in the Directive 1999/5/EC of the European Parliament and of the Council of 9 March 1999 on radio equipment and telecommunications terminal equipment (R&TTE Directive) and satisfies all the technical regulations applicable to the product within this Directive

IEC 60945 Ed.4.0: 2002 EMC related items
IEC 60950-1 Ed.2.0: 2005 Safety related items
IEC 60950-1 Ed.2.0 A1: 2009 Safety related items

ITU-R M.1177-3: Spurious related items
ITU-R SM.1539-1: Spurious related items
ITU-R SM.1541-2: Spurious related items
ITU-R SM. 329-10: Spurious related items

(title and/or number and date of issue of the standard(s) or other normative document(s))

For assessment, see

- Statement of Opinion No: 09214003 issued by Telefication, The Netherlands.

On behalf of Furuno Electric Co., Ltd.

Takahiko Kusuda
Manager, QMS Secretariat
Quality Assurance Department

Nishinomiya City, Japan
January 27, 2011

(Place and date of issue)

(name and signature or equivalent marking of authorized person)